

PRODUCTPROFILE

Catalogue number: 031A18150M4

Partnumber: 746418

PreCONNECT® STANDARD TRUNK
48 channels, 96 fibers, 50/125µmOM4, violet
Connector side A: LC-Compact MM
Connector side B: LC-Compact MM
Cable U-DQ(ZN)BH8x12G50/125µmOM4

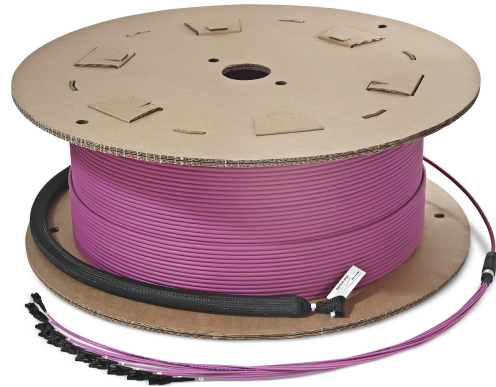

Related documents:

DS_FASER OM4BI_OE	Fiber Data Sheet
DS_LC_COMPACT_STECKER_SHORT_C	Steckerdatenblatt
DS_U-DQZNBHNX4000-PVP_L_OE	Kabeldatenblatt
PRECONNECT_STANDARD_OE	Product Information

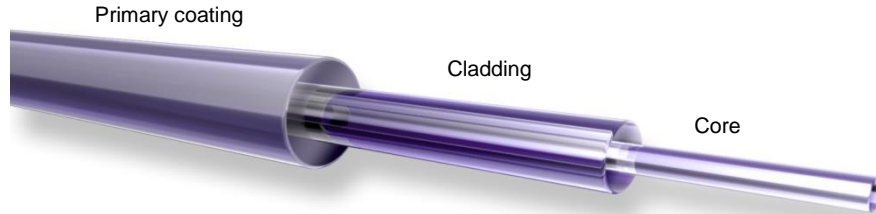

Standards

Graded index fiber 50/125µm according to
 -ISO/IEC 11801 und EN 50173-1 OM4
 -IEC 60793-2-10 type A1a.3
 -ITU G.651.1
 -TIA/EIA 492AAAD

Structure

Silica fiber with two layer acrylate primary coating

Geometrical properties

Core diameter	50 µm +/- 2.5 µm
Cladding diameter	125 µm +/- 1 µm
Core non-concentricity	< 5 %
Cladding non-circularity	< 1 %
Core-Cladding concentricity	< 1.5 µm
Primary coating diameter	242 µm +/- 5 µm
Coating-Cladding concentricity	< 12 µm

Mechanical properties

Break strength SCREEN-Test 1 % strain for 1 s @100 kpsi

Thermal properties

Operating temperature range -60 to +85°C

Dieses Dokument ist urheberrechtlich geschützt • This document is protected by copyright • Rosenberger OSI GmbH & Co. OHG

Optical fiber OM4
bend insensitive

059A0381OM4BI

Transmission characteristics

Attenuation:

@ 850 nm max. 2.3 dB/km
@ 1300 nm max. 0.6 dB/km

Macrobending, induced attenuation:

100 turns, 37.5 mm \leq 0.05 dB @ 850 nm
100 turns, 37.5 mm \leq 0.15 dB @ 1300 nm
2 turns, 15 mm \leq 0.1 dB @ 850 nm
2 turns, 15 mm \leq 0.3 dB @ 1300 nm
2 turns, 7.5 mm \leq 0.2 dB @ 850 nm
2 turns, 7.5 mm \leq 0.5 dB @ 1300 nm

Bandwidth (Overfilled launch):

@ 850 nm min. 3500 MHz x km
@ 1300 nm min. 500 MHz x km

Effective modal Bandwidth-length-product (EMB):

@ 850 nm min. 4700 MHz x km

Numerical aperture: 0.200 +/- 0.015

Effective group index of refraction:

@ 850 nm 1.480
@ 1300 nm 1.479

Backscatter attenuation @ 1ns pulse width:

@ 850 nm -68 dB
@ 1300 nm -76 dB

Maximum possible transmission channels lengths:

Ethernet:

1 GBE 100GBASE-SX: min. 1100 m @ max. 3.56 dB channel attenuation ¹⁾
10 GBE 10GBASE-SR: min. 550 m @ max. 2.60 dB channel attenuation ¹⁾
40 GBE 40GBASE-SR4: min. 170 m @ max. 1.50 dB channel attenuation ¹⁾
100 GBE 100GBASE-SR10: min. 170 m @ max. 1.50 dB channel attenuation ¹⁾

Fibre Channel:

8 GFC (800-SN): min. 245 m @ max. 1.76 dB channel attenuation ¹⁾
16 GFC (1600-SN): min. 165 m @ max. 1.51 dB channel attenuation ¹⁾

¹⁾ Inclusive max. 1.0 dB for connections (connectors and splices)

While the information has been carefully compiled to the best of our knowledge, nothing is intended as representation or warranty on our part and no statement herein shall be construed as recommendation to infringe existing patents. In the effort to improve our products, we reserve the right to make changes judged to be necessary.

Draft	Date	Approved	Date	Rev.	Engineering change number	Name	Date
H. Jungbäck	26-10-15	P. Maier	26-10-15	004	without	H. Jungbäck	26-10-15

LC-COMPACT Shortboot connector

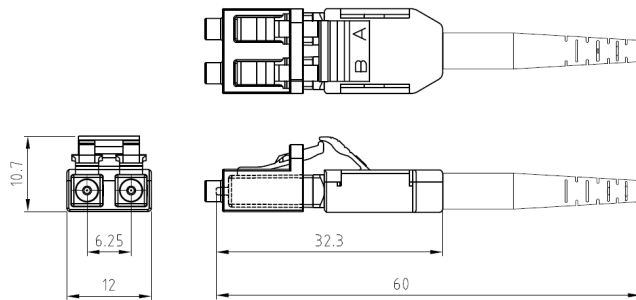

Properties and applications

- LC-Duplex connector with compact and rugged backshell with short central strain relief and boot for round cable (Uniboot)
- A/B polarity can be easily tool-less changed
- The short boot enables the use of the connector in applications with low depth, like ODF Optical Distribution Frames
- Translucence duplex protection cap, fast and secure to handle and permeable for the light of laser pointers (visual fault locators)

Standards

LC-Duplex acc. to IEC/DINEN 61754-20 and EIA/TIA 604-10

Material

- Ferrule: Zirconia ceramic, Ø 1.25 mm
- Body: PEI, flammability UL94-V0
- Boot: TPE, flammability UL94-V0
- Protection cap: POM, flammability UL94-HB

Optical properties

The quality feature of the connector at your product is identified by the part number:

- BASIC: Part numbers like XXXAXXXX
- PURE: Part numbers with "P" at their end, XXXAXXXXP

Details about PURE see Produktinfo_Qualitätsmerkmal-PURE_od

Insertion Loss IL acc. to IEC61300-3-4, Method B, against reference, maximum [dB]:

	Quality feature	BASIC	PURE
- Singlemode SM, 9/125µm		0.30	0.20
- Multimode OM1, 62.5/125µm		0.30	---
- Multimode low IL OM2, OM3, OM4, OM5, 50/125µm		0.15	0.15

Insertion Loss IL „random mated“ acc. to IEC61300-3-34, Method 2, [dB]:

Quality feature	BASIC	mean value	maximum
- Singlemode SM, 9/125µm		0.13	0.50
- Multimode low IL OM2, OM3, OM4, OM5, 50/125µm		0.03	0.27

Insertion Loss IL quality feature PURE "random mated" application limit value, maximum [dB]:

- Singlemode SM, 9/125µm	97%	0.25
- Multimode low IL OM2, OM3, OM4, OM5, 50/125µm	100%	0.40

GHMT PVP certificate
No.: c6997X-XX
No.: c6998X-XX



Dieses Dokument ist urheberrechtlich geschützt • This document is protected by copyright • Rosenberger OSI GmbH & Co. OHG

LC-COMPACT Shortboot connector

Optical properties

Return Loss RL acc. to IEC61300-3-6, Method 1, against reference, minimum [dB]:

	Quality feature	BASIC	PURE
- Singlemode SM, 9/125µm, PC 0°		45	45
- Singlemode SM, 9/125µm, UPC 0°		55	55
- Singlemode SM, 9/125µm, APC 8°		65	70
- Multimode all classes		35	40

Mechanical properties

- Mating cycles min. 1000, IL increase < 0.2 dB
- Strain relief max. 100 N, dependent on cable type

Thermal properties

- Operation temperature range -40°C to +85°C, dependent on cable type
- Storage temperature range -40°C to +85°C

Cable diameters

- Round cable types Ø 2.0 to 3.0 mm

Colors

Connector body / boot:

- Singlemode SM, 9/125µm, PC and UPC 0° blue / blue
- Singlemode SM, 9/125µm, APC 8° green / green
- Multimode OM1, 62.5/125µm beige / white
- Multimode OM2, OM3, OM4, OM5, 50/125µm black / black

Polarity change

1) Remove the connector top cover by inserting a fingernail or a small lever into the crack that separates the two halves.

2) Carefully swap position of the connectors by lifting them up and out of the bottom housing.

3) Reposition the top cover and snap into place.



While the information has been carefully compiled to the best of our knowledge, nothing is intended as representation or warranty on our part and no statement herein shall be construed as recommendation to infringe existing patents. In the effort to improve our products, we reserve the right to make changes judged to be necessary.

Draft	Date	Approved	Date	Rev.	Engineering change number	Name	Date
H. Jungbäck	2018-12-13	A. Burggraf	2018-12-13	009	----	H. Jungbäck	2022-10-07

Fiber Optic Cable
U-DQ(ZN)BH nxm 4000N GHMT PVP certified

030AXXX

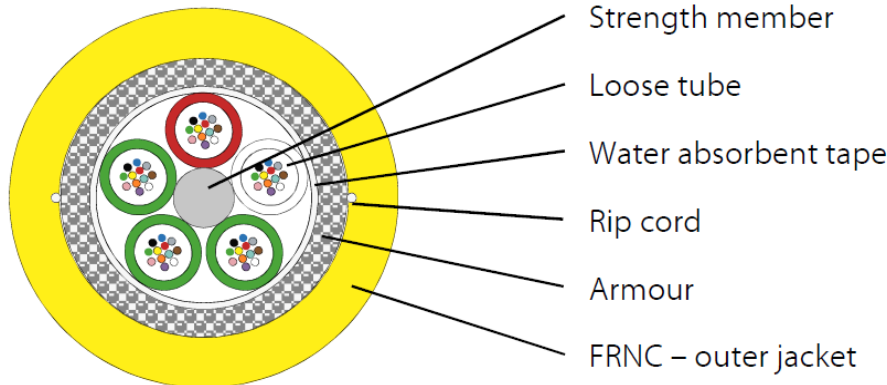

PVP only with singlemode and OM4 fibers

Standards

IEC 60794-2
EN 50575: 2014 + A1: 2016: No. of Declaration of Performance CDERF0000090

Structure

- Loose tube** Jelly filled loose tube, outer diameter 2.3 mm with 2–12 colour-coded optical fibres
Fibre colours: red, green, blue, yellow, white, grey, brown, violet, turquoise, black, orange, pink
Tube colours: counting tube red, counting direction tube white, other tubes yellow (E9/125), green (G50/125), or blue (G62.5/125)
- Stranding** Loose tubes and if necessary fillers stranded around a central strength member (FRP). Strength member can be upcoated.
With water absorbent tape.
- Armour** Multifunctional E-glass yarns, wrapped in two layers (left and right spin), as strain relief elements and non-metallic rodent protection
- Outer jacket** Halogen-free and flame-retardant material (FRNC), with approx. 1.5mm
Standard colours: Singlemode yellow
Multimode 50 µm: orange or green
Multimode OM3: aqua (turquoise)
Multimode OM4: violett
Multimode OM5: limegreen
Multimode 62,5 µm: orange
Marking see separate drawing
Two diametrically opposed ripcords under the jacket
Outer diameter see table below

Constr uction	max. no. of fibers	Outer diameter [mm]	Weight [kg/km]	Fire load [MJ/m]	min. bending radius [mm]	
					during installation	installed
1 x m	12	11,5	136	1,90	230	170
2 x m	24	11,5	136	1,90	230	170
3 x m	36	11,5	136	1,90	230	170
4 x m	48	11,5	136	1,90	230	170
5 x m	60	11,5	136	1,90	230	170
6 x m	72	11,5	136	1,90	230	170
8 x m	96	11,9	156	2,10	235	175
10 x m	120	13,2	182	2,80	265	200
12 x m	144	15,7	245	4,60	320	240

Dieses Dokument ist urheberrechtlich geschützt • This document is protected by copyright • Rosenberger OSI GmbH & Co. OHG

Fiber Optic Cable
U-DQ(ZN)BH nxm 4000N GHMT PVP certified

030AXXXX

Mechanical characteristics

- Max. tensile force acc. IEC 60794-1-2 E1 **4000 N**
- Max. crush resistance acc. IEC 60794-1-2 E3 **3000 N/dm, 10 min. (long term)**
- Impact resistance acc. IEC 60794-1-2 E4 **5 impacts, 3.0 Nm, R = 12.5 mm**
- Cable bend acc. IEC 60794-1-2 E11A **1 cycle, R = 10 x outer diameter, n = 5 (windings)**
- Longitudinally watertight acc. IEC 60794-1-2 F5A **l = 3 m, t = 24 h**

Thermal characteristics

- Transport and storage **- 40 °C to + 70 °C**
- Installation **- 5 °C to + 50 °C**
- In use acc. IEC 60794-1-2 F1 **- 40 °C to + 60 °C**

Chemical Characteristics

UV-resistance of outer-jacket

Fire performance

- Cable is flame-retardant acc. to IEC 60332-1-2 and IEC 60332-3-22 Cat. A
- Smoke density acc. to IEC 61034
- Halogen-free acc. to IEC 60754-1
- Acidity of the combustion gases acc. to IEC 60754-2
- Fire Class according EN 13501-6 E_{ca}

Transmission characteristics

See fiber data sheets

Application

- Dry, longitudinally and transversely waterproof fibre optic cable with non-metallic rodent protection and for higher tensile force
- Good installation through ripcords to open the jacket
- For fixed installation indoor and outdoor, in cable ducts, tubes and also suitable for interconnections
- Mechanical installation is only permitted when using force measuring devices with recording function
- Not suitable for underground laying (direct buried)

Packaging

Disposable drums

While the information has been carefully compiled to the best of our knowledge, nothing is intended as representation or warranty on our part and no statement herein shall be construed as recommendation to infringe existing patents. In the effort to improve our products, we reserve the right to make changes judged to be necessary.

Draft	Date	Approved	Date	Rev.	Engineering change number	Name	Date
S. Wiener	2020-02-14	H. Jungbäck	2020-02-14	001			

PreCONNECT® STANDARD

PRODUCT INFORMATION

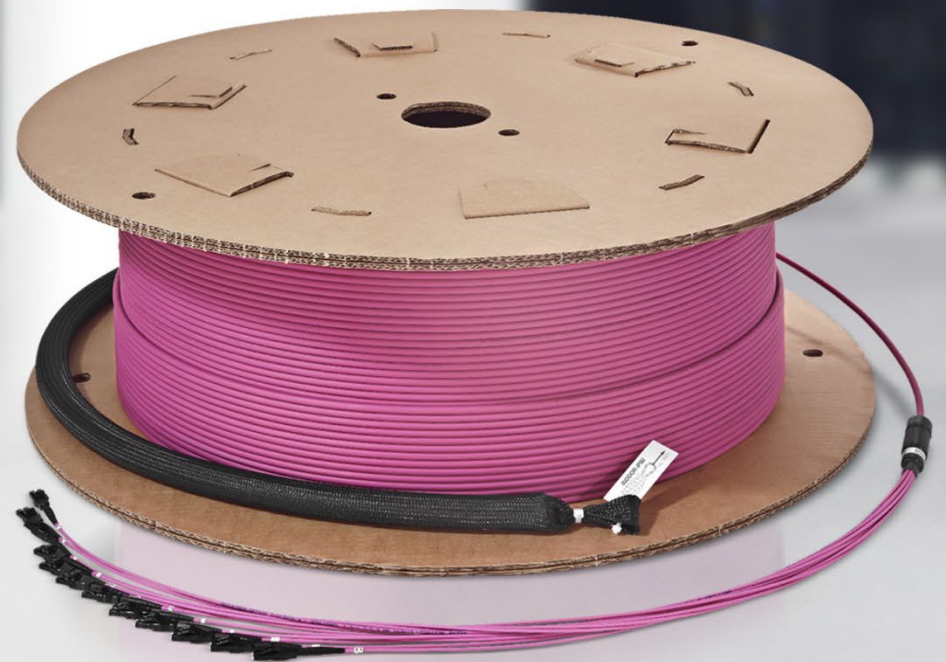

PreCONNECT® STANDARD solution is available in two end face quality features: BASIC and PURE**Define the end-face quality according to your application requirements:**

Quality feature BASIC is our well-proven, high-grade, standards compliant product in terms of end-face geometry, defect, and cleanliness, providing excellent IL and RL performance:

- The PreCONNECT® factory-assembled plug & play system enables quick and reliable, cost efficient, installation and performance
- Harmonized modular components of the quality feature BASIC solution ensure end to end performance of the entire channel

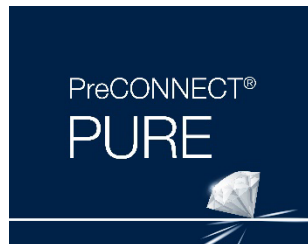

Quality feature PURE is the enhanced version of our quality feature BASIC, but with more stringent defect and cleanliness screening and factory sealed, tamper evident adapter-interfaces.

- Guaranteed protection of the polished connector end-face against contamination and damage through sealed adapter-interfaces, enabling time savings during initial installation and commissioning due to the elimination of the need for cleaning and testing*/**.
- Quality feature PURE provides an industry leading low random mate insertion and return loss (mean) which enables up to six (6) mated pairs in a 10G/OM4 application up to 300m.

Part numbers:

Quality feature BASIC: The part numbers XXXAXXXX listed in this document are valid for the BASIC quality feature.

Quality feature PURE: Add a "P" to the end of the quality feature BASIC part number (*Example: XXXAXXXXP*)

(Note: PURE trunk cables have factory attached sealed coupling adapters incorporated and thus utilize empty patch panels and enclosures)

** While Rosenberger does not require permanent link or channel testing for warranty registration of PURE installations due to guaranteed performance, certain customers will require testing documentation for their records.*

*** Only applicable when all components are of quality feature PURE and installed by trained PURE installers.*

Applications:

Infrastructure cabling within data centers, office buildings and campus

System consists of:

- Factory assembled FO loose tube cables, FRNC-LSZH indoor, universal and HDPE outdoor cables, up to 144 fibers
- With connector systems LC, MDC, SC and E-2000®

Features:

- For larger numbers of fibers and longer lengths:
 - Trunks up to 144 fibers
 - Up to 24 fibers practical lengths: Cost comparison by break-even calculation versus PreCONNECT® BREAKOUT
- Migration to MPO based parallel optics applications possible by using migration-harnesses

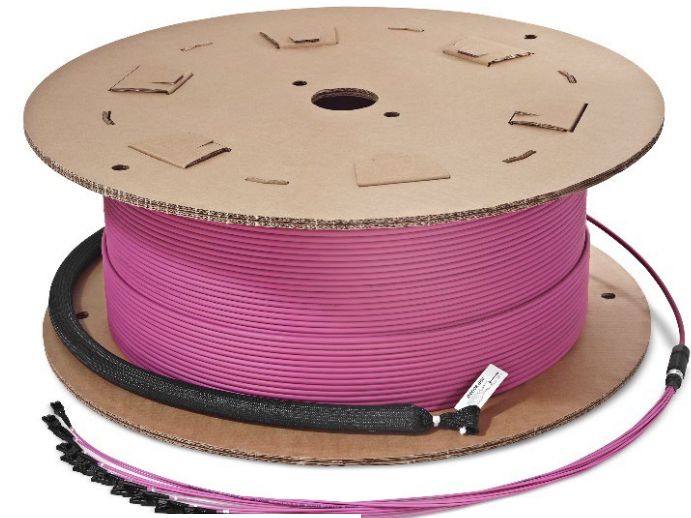

Your benefits at a glance:

- Most cost-effective solution for trunks larger 24 fibers and long lengths
- Fast and safe installation through factory assembled plug & play systematic
- Highest quality and cost-efficiency through factory assembling
- PreCONNECT® cabling systems consist of perfectly harmonized modular single components

Applications:

Infrastructure cabling of data centers, office buildings and campus.

- **Universal to use FO cabling system up to 144 fibers per trunk**
- **Cost and attenuation optimized**
- **Focused on the useful and necessary**

System description:

Our PreCONNECT® STANDARD cabling system consists of:

- Trunk called factory assembled FO loose tube cables up to 144 fibers, with „standard stepped“ connector legs
- therefore, explicitly developed 19” panel systems
- a large variety of patchcords and accessories
- and patch location racks

Rosenberger OSI brought already 1991 high fibercount factory assembled FO trunk cables to the market. PreCONNECT® STANDARD was the first in Europe developed and manufactured, high fibercount and modular „plug & play“ FO cabling system.

Properties:

Both cable ends of the PreCONNECT® STANDARD trunks are molded within the cable dividers and assembled with „standard stepped“ connector legs. The „standard stepped“ connector legs are fitting for all PreCONNECT® panel systems.

The PreCONNECT® cable divider is a splice-less furcation to separate the fibers of loose tube cables. He is one of the mechanically and thermally most robust cable dividers for loose tube cables at smallest diameters. With its integrated PreCONNECT® square interface, the cable divider can be tool-less hooked into PreCONNECT® panels for tensile and torsion resistant fixing of the trunks.

Installation protection: The connector legs and cable dividers are equipped with 600 N tensile strength, crush resistant, kink and torsion resistant, installation tubes. Alternatively indoor IP50 dust-proof or outdoor IP67 water-proof deliverable.

Polarity: The connector legs are alpha numerical uniquely coded. The standard polarity is „channel-wise crossed“ (pairwise flipped) for full-duplex transmission systems – A1 to B1, A2 to B2, etc. On request „uncrossed“ deliverable.

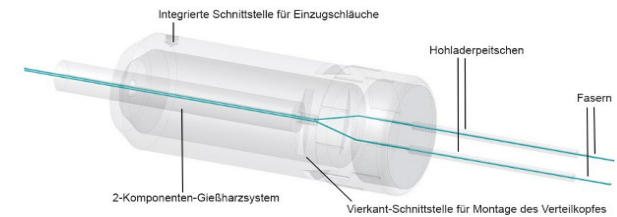

Properties:

Length definition:

- Order-length = length between the connectors of the longest legs at both sides, not between the PreCONNECT® cable dividers.
- Possible order-lengths: From 5 to 2000 meter

Length tolerances:

Trunk length	Tolerance
<= 10m	+/- 50cm
> 10m <= 30m	+/- 100cm
> 30m <= 100m	+/- 150cm
> 100m	+/- 2%

Operating temperature range: -10°C to +60°C

Delivery form:

- Dependent on the length as cable ring or on cardboard or wooden drum
- Insertion loss and return loss measured acc. to IEC 61300-3-4, method B, MM 850/1300nm and SM 1310/1550nm, with measurement protocol
- Product label with serial number at both sides

Standard stepped “A“ and “E“ leg lengths and installation tube diameters of PreCONNECT® STANDARD trunks, all types of connectors except SC-Duplex ²⁾ Steps channel/fiber 1 to n: 1 = long, n = short									
Number of channels/fibers	4/8	6/12	8/16	12/24	18/36	24/48	36/72	48/96	72/144
“A” leg lengths stepped from to [cm] ¹⁾	45 to 75	45 to 75	45 to 73	45 to 89	45 to 70	45 to 89	45 to 70	45 to 70	45 to 75
“E” leg lengths stepped from to [cm] ¹⁾	77 to 107	77 to 107	77 to 105	77 to 121	77 to 102	77 to 121	77 to 102	77 to 102	77 to 107
Outer diameter installation tube IP50 Indoor and IP67 Outdoor [mm]	30	30	30	30	40	40	55	75	75

¹⁾ Production tolerance – 5 cm / ²⁾ Installation tube diameter of trunks with SC-Duplex on request

Properties:

Trunk cable types:

PreCONNECT® STANDARD trunks are deliverable with all common loose tube cables up to 144 fibers, mostly used:

- Indoor cable I-B(ZN)BH, CPR class B2ca
- Universal cable U-DQ(ZN)BH, CPR class Dca or Cca dependent on stock
- Outdoor cable A-DQ(ZN)B2Y

Cable data, see separate cable data sheets.

Fiber types:

With all common fiber types deliverable.

Bend-insensitive fibers by default.

Fiber data, see separate fiber data sheets.

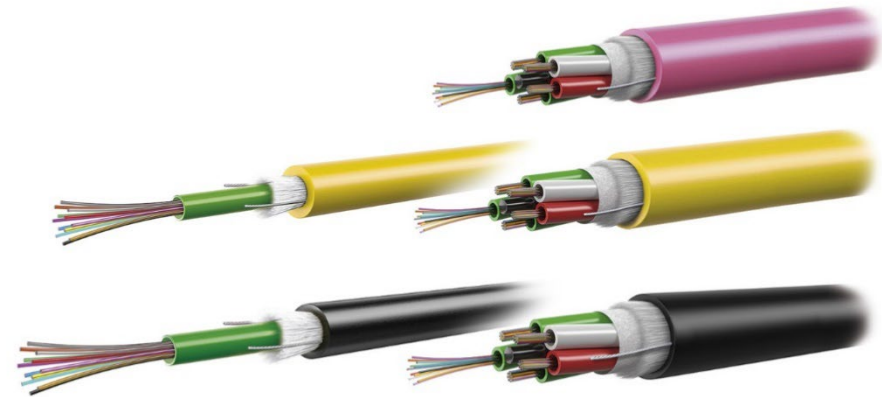

Connector types:

With all common connector types deliverable.

Connector data, see separate connector data sheets.

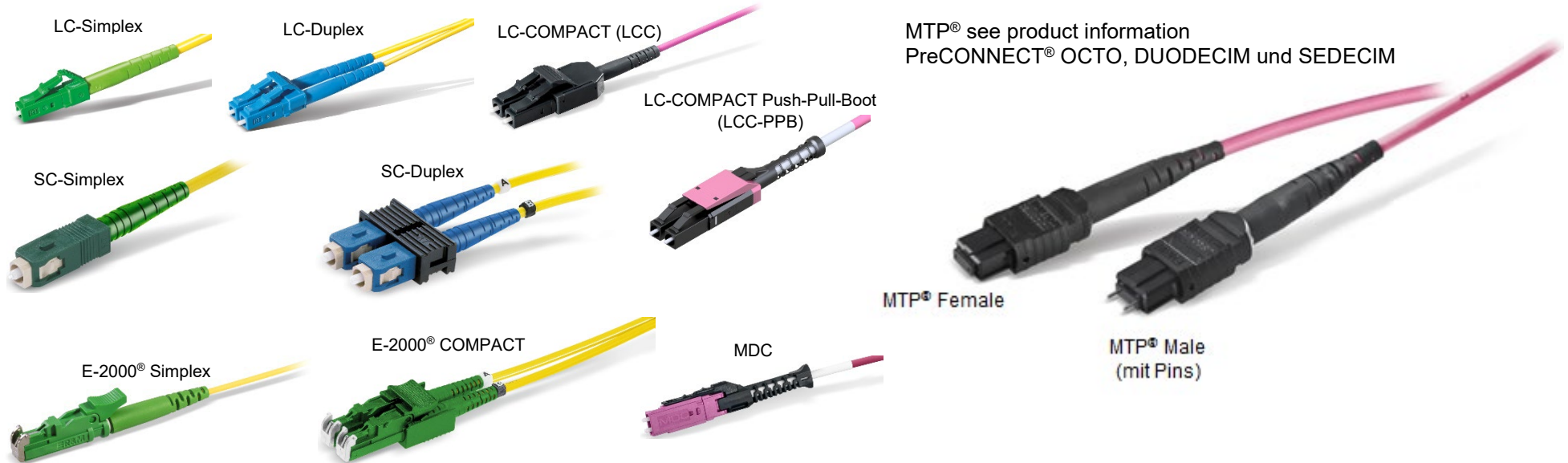

Application of PreCONNECT® STANDARD Trunks and Patchcords with LC-COMPACT (LCC) and LC-COMPACT Push-Pull-Boot (LCC-PPB) in our 19" panel systems and Trunk leg lengths:

19" panel systems	LC-Duplex port density per HU	Trunks with LCC	Trunks with LCC-PPB	Patchcords with LCC	Patchcords with LCC-PPB	Trunk leg lengths
SMAP-G2 SD	48	✓	✗	✓	✗	standard stepped "A length legs"
SMAP-G2 HD	72	✓	recommended	✗	✓ required	
SMAP-G2 UHD	96	✗	✓ required	✗	✓ required	
Conventional	24	✓	✗	✓	✗	standard stepped "A length legs"
ODF LARO	144 in 5 ETSI HU	✓	recommended	✗	✓ required	extended stepped "E length legs"

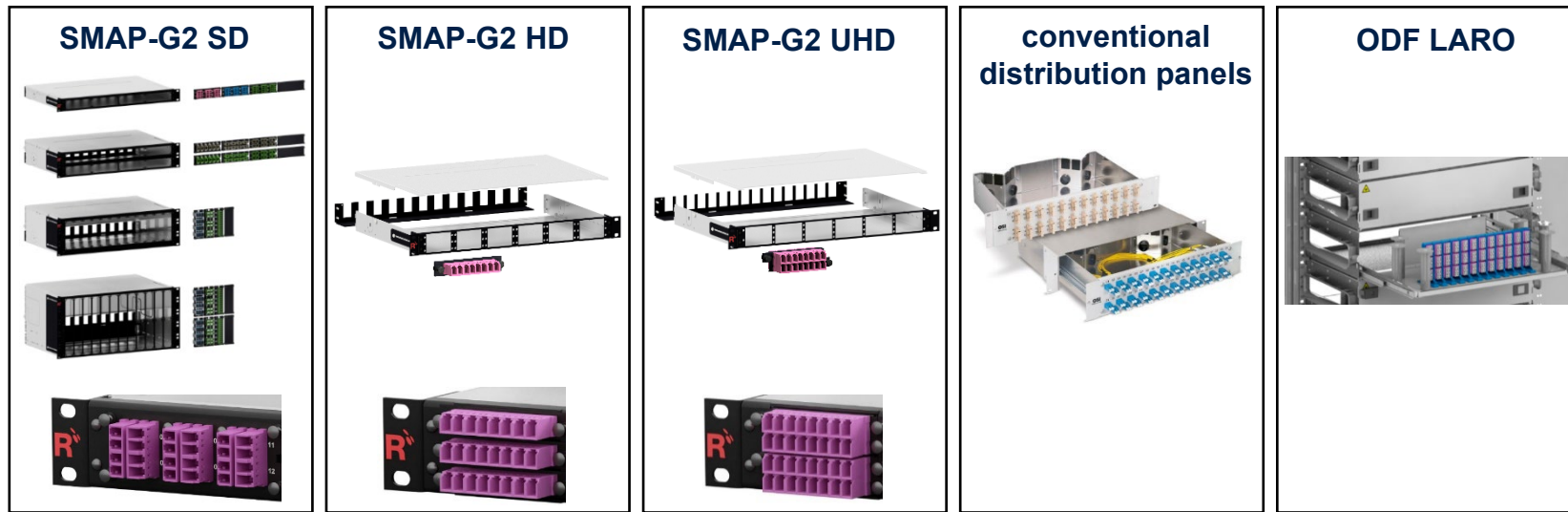

LC-COMPACT (LCC)



LC-COMPACT Push-Pull-Boot (LCC-PPB)



**PreCONNECT® STANDARD trunks
with indoor cable I-B(ZN)BH
CPR class B2ca:**

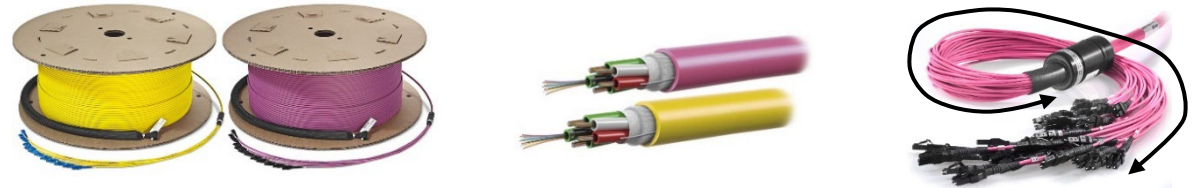

PreCONNECT® STANDARD Trunks with extended stepped „E length legs“ must be applied in ODF LARO panels.

Part numbers							
Channels/ Fibers	Connectors on both sides	With standard stepped “A length legs” compatible to all our SMAP and conventional panels			With extended stepped “E length legs” compatible to ODF LARO panels		
		SM PC 0°	SM APC 8°	OM4	SM PC 0°	SM APC 8°	OM4
6/12	LCC	024A0195G657A1	024A0143G657A1	024A0142OM4	024E0195G657A1	024E0143G657A1	024E0142OM4
	LCC-PPB	024A0225G657A1	024A0226G657A1	024A0227OM4	024E0225G657A1	024E0226G657A1	024E0227OM4
	MDC	on request	on request	on request	on request	on request	on request
8/16	LCC	024A01187G657A1	on request	024A0188OM4	on request	on request	on request
	LCC-PPB	on request	on request	on request	on request	on request	on request
	MDC	024A0260G657A1	auf Anfrage	024A0259OM4	on request	on request	on request
12/24	LCC	024A0175G657A1	024A0144G657A1	024A0127OM4	024E0175G657A1	024E0144G657A1	024E0127OM4
	LCC-PPB	024A0228G657A1	024A0229G657A1	024A0230OM4	024E0228G657A1	024E0229G657A1	024E0230OM4
	MDC	024A0244G657A1	on request	024A0261OM4	on request	on request	on request
16/32	LCC	024A0163G657A1	on request	024A0165OM4	on request	on request	on request
	LCC-PPB	on request	on request	on request	on request	on request	on request
	MDC	024A0262G657A1	on request	024A0263OM4	on request	on request	on request
18/36	LCC	024A0100G657A1	on request	024A0101OM4	on request	on request	on request
	LCC-PPB	on request	on request	on request	on request	on request	on request
	MDC	on request	on request	on request	on request	on request	on request
24/48	LCC	024A0102G657A1	024A0126G657A1	024A0103OM4	024E0102G657A1	024E0126G657A1	024E0103OM4
	LCC-PPB	024A0231G657A1	024A0232G657A1	024A0233OM4	024E0231G657A1	024E0232G657A1	024E0233OM4
	MDC	024A0246G657A1	on request	024A0247OM4	on request	on request	on request

Technical data of connectors, fibers and cables on request via the product profile of your selected trunks.

**PreCONNECT® STANDARD trunks
with indoor cable I-B(ZN)BH
CPR class B2ca:**

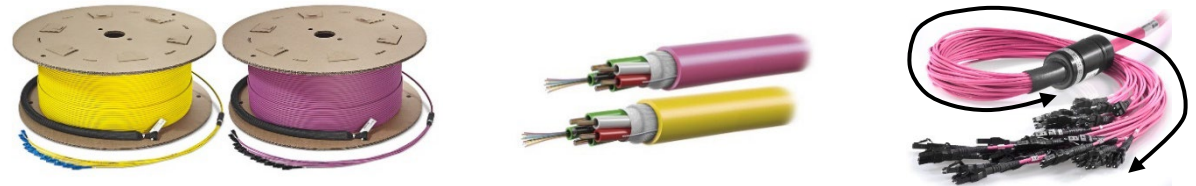

PreCONNECT® STANDARD Trunks with extended stepped „E length legs“ must be applied in ODF LARO panels.

Part numbers							
Channels/ Fibers	Connectors on both sides	With standard stepped “A length legs” compatible to all our SMAP and conventional panels			With extended stepped “E length legs” compatible to ODF LARO panels		
		SM PC 0°	SM APC 8°	OM4	SM PC 0°	SM APC 8°	OM4
32/64	LCC	024A0161G657A1	on request	024A0164OM4	on request	on request	on request
	LCC-PPB	on request	on request	on request	on request	on request	on request
	MDC	024A0256G657A1	on request	024A0248OM4	on request	on request	on request
36/72	LCC	024A0174G657A1	024A0176G657A1	024A0105OM4	on request	on request	on request
	LCC-PPB	on request	on request	on request	on request	on request	on request
	MDC	on request	on request	on request	on request	on request	on request
48/96	LCC	024A0106G657A1	024A0128G657A1	024A0107OM4	024E0106G657A1	024E0128G657A1	024E0107OM4
	LCC-PPB	024A0234G657A1	024A0235G657A1	024A0236OM4	024E0234G657A1	024E0235G657A1	024E0236OM4
	MDC	on request	on request	on request	on request	on request	on request
64/128	LCC	024A0183G657A1	on request	024A0162OM4	on request	on request	on request
	LCC-PPB	on request	on request	on request	on request	on request	on request
	MDC	024A0258G657A1	on request	024A0257OM4	on request	on request	on request
72/144	LCC	024A0108G657A1	024A0129G657A1	024A0109OM4	024E0108G657A1	024E0129G657A1	024E0109OM4
	LCC-PPB	024A0237G657A1	024A0238G657A1	024A0239OM4	024E0237G657A1	024E0238G657A1	024E0239OM4
	MDC	on request	on request	on request	on request	on request	on request

Technical data of connectors, fibers and cables on request via the product profile of your selected trunks.

**PreCONNECT® STANDARD trunks
with indoor cable I-B(ZN)BH
CPR class B2ca:**

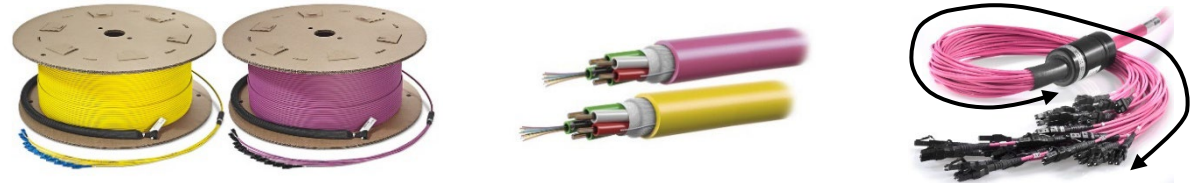

PreCONNECT® STANDARD Trunks with extended stepped „E length legs“ must be applied in ODF LARO panels.

Part numbers							
Channels/ Fibers	Connectors on both sides	With standard stepped “A length legs” compatible to all our SMAP and conventional panels			With extended stepped “E length legs” compatible to ODF LARO panels		
		SM PC 0°	SM APC 8°	OM4	SM PC 0°	SM APC 8°	OM4
6/12	SC-Duplex	on request	on request	on request	on request	on request	on request
	E-2000® Simplex	on request	on request	on request	on request	on request	on request
12/24	SC-Duplex	024A0179G657A1	on request	024A0178OM4	024E0179G657A1	on request	024E0178OM4
	E-2000® Simplex	on request	on request	on request	on request	on request	on request
24/48	SC-Duplex	024A0147G657A1	024A0177G657A1	024A0169OM4	024E0147G657A1	024E0177G657A1	024E0169OM4
	E-2000® Simplex	on request	024A0149G657A1	on request	on request	024E0149G657A1	on request
48/96	SC-Duplex	on request	on request	on request	on request	on request	on request
	E-2000® Simplex	on request	on request	on request	on request	on request	on request
72/144	SC-Duplex	on request	on request	on request	on request	on request	on request
	E-2000® Simplex	on request	on request	on request	on request	on request	on request

Technical data of connectors, fibers and cables on request via the product profile of your selected trunks.

PreCONNECT® STANDARD trunks
with universal cable U-DQ(ZN)BH
CPR class Dca or Cca
dependent on stock:



PreCONNECT® STANDARD Trunks with extended stepped „E length legs“ must be applied in ODF LARO panels.

Part numbers							
Channels/ Fibers	Connectors on both sides	With standard stepped “A length legs” compatible to all our SMAP and conventional panels			With extended stepped “E length legs” compatible to ODF LARO panels		
		SM PC 0°	SM APC 8°	OM4	SM PC 0°	SM APC 8°	OM4
6/12	LCC	031A1800G657A1	031A1831G657A1	031A1810OM4	031E1800G657A1	031E1831G657A1	031E1810OM4
	LCC-PPB	on request	on request	on request	on request	on request	on request
	SC-Duplex	031A1504G657A1	on request	031A1604OM4	031E1504G657A1	on request	031E1604OM4
	E-2000® Simplex	on request	031A1013G657A1	on request	on request	031E1013G657A1	on request
12/24	LCC	031A1801G657A1	031A1808G657A1	031A1811OM4	031E1801G657A1	031E1808G657A1	031E1811OM4
	LCC-PPB	on request	on request	on request	on request	on request	on request
	SC-Duplex	031A1506G657A1	on request	031A1606OM4	031E1506G657A1	on request	031E1606OM4
	E-2000® Simplex	on request	031A1015G657A1	on request	on request	031E1015G657A1	on request
24/48	LCC	031A1803G657A1	031A1807G657A1	031A1813OM4	031E1803G657A1	031E1807G657A1	031E1813OM4
	LCC-PPB	on request	on request	on request	on request	on request	on request
	SC-Duplex	031A1508G657A1	on request	031A1608OM4	031E1508G657A1	on request	031E1608OM4
	E-2000® Simplex	on request	031A1016G657A1	on request	on request	031E1016G657A1	on request
48/96	LCC	031A1805G657A1	on request	031A1815OM4	031E1805G657A1	on request	031E1815OM4
	LCC-PPB	on request	on request	on request	on request	on request	on request
	SC-Duplex	031A1511G657A1	on request	031A1611OM4	031E1511G657A1	on request	031E1611OM4
	E-2000® Simplex	on request	031A1009G657A1	on request	on request	031E1009G657A1	on request
72/144	LCC	031A1806G657A1	on request	031A1816OM4	031E1806G657A1	on request	031E1816OM4
	LCC-PPB	on request	on request	on request	on request	on request	on request
	SC-Duplex	031A1510G657A1	on request	031A1610OM4	031E1510G657A1	on request	031E1610OM4
	E-2000® Simplex	on request	031A1018G657A1	on request	on request	031E1018G657A1	on request

Technical data of connectors, fibers and cables on request via the product profile of your selected trunks.

PreCONNECT® STANDARD trunks with outdoor cable A-DQ(ZN)B2Y:

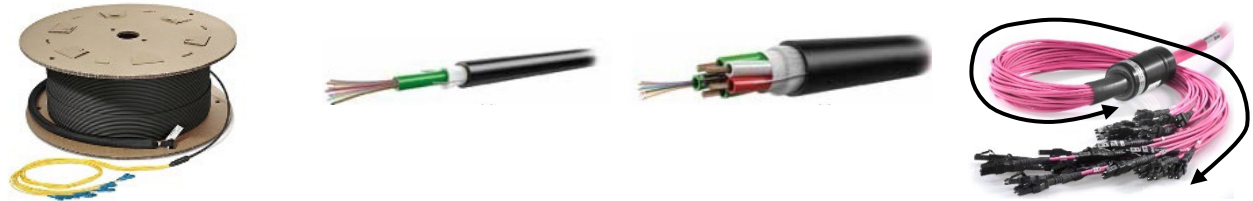

PreCONNECT® STANDARD Trunks with extended stepped „E length legs“ must be applied in ODF LARO panels.

Part numbers							
Channels/ Fibers	Connectors on both sides	With standard stepped “A length legs” compatible to all our SMAP and conventional panels			With extended stepped “E length legs” compatible to ODF LARO panels		
		SM PC 0°	SM APC 8°	OM4	SM PC 0°	SM APC 8°	OM4
6/12	LCC	010A2079G657A1	on request	010A2080OM4	010E2079G657A1	on request	010E2080OM4
	LCC-PPB	on request	on request	on request	on request	on request	on request
	SC-Duplex	010A1504G657A1	on request	010A1604OM4	010E1504G657A1	on request	010E1604OM4
	E-2000® Simplex	on request	010A1013G657A1	on request	on request	010E1013G657A1	on request
12/24	LCC	010A2077G657A1	on request	010A2078OM4	010E2077G657A1	on request	010E2078OM4
	LCC-PPB	on request	on request	on request	on request	on request	on request
	SC-Duplex	010A1506G657A1	on request	010A1606OM4	010E1506G657A1	on request	010E1606OM4
	E-2000® Simplex	on request	010A1015G657A1	on request	on request	010E1015G657A1	on request
24/48	LCC	010A1801G657A1	on request	010A1813OM4	010E1801G657A1	on request	010E1813OM4
	LCC-PPB	on request	on request	on request	on request	on request	on request
	SC-Duplex	010A1508G657A1	on request	010A1608OM4	010E1508G657A1	on request	010E1608OM4
	E-2000® Simplex	on request	010A1016G657A1	on request	on request	010E1016G657A1	on request
48/96	LCC	010A2075G657A1	on request	010A2076OM4	010E2075G657A1	on request	010E2076OM4
	LCC-PPB	on request	on request	on request	on request	on request	on request
	SC-Duplex	010A1511G657A1	on request	on request	010E1511G657A1	on request	on request
	E-2000® Simplex	on request	010A1009G657A1	on request	on request	010E1009G657A1	on request
72/144	LCC	010A1806G657A1	on request	010A1816OM4	010E1806G657A1	on request	010E1816OM4
	LCC-PPB	on request	on request	on request	on request	on request	on request
	SC-Duplex	010A1510G657A1	on request	on request	010E1510G657A1	on request	on request
	E-2000® Simplex	on request	010A1018G657A1	on request	on request	010E1018G657A1	on request

Technical data of connectors, fibers and cables on request via the product profile of your selected trunks.

About Rosenberger OSI:

Since 1991, Rosenberger Optical Solutions & Infrastructure (Rosenberger OSI) has been a recognized expert for fiber-based connectivity, cabling solutions and infrastructure services in the areas of data centers, local area networks, mobile networks and industrial applications. As an integrated solution provider, we have high expertise in the development and operational excellence in the production of system solutions for communication networks. Our comprehensive services enable the secure and efficient operation of digital infrastructures. This combination, combined with our strong customer focus, makes us unique and a strong partner in the global market.

Rosenberger OSI has been part of the globally operating Rosenberger Group since 1998. The Rosenberger Group is a leading global provider of high-frequency, high-voltage and fiber optic connectivity solutions with headquarters in Germany. For further information, please visit:

www.rosenberger.com/osi

Rosenberger

Rosenberger-OSI GmbH & Co. OHG

Optical Solutions & Infrastructure | Endorferstr. 6 | 86167 Augsburg | GERMANY | Telephone: +49 821 24924-0
info-osi@rosenberger.com | www.rosenberger.com/osi

Rosenberger® is a registered trademark of Rosenberger Hochfrequenztechnik GmbH & Co. KG. All rights reserved. © Rosenberger 2022

For technical reasons, we reserve us the right to make any deviations from the illustrations in the product information.
Transfer to third party only by authority of Rosenberger-OSI GmbH & Co. OHG- All rights reserved.

Creation date: 2022-08-23

Valid since: 2022-10-06

Revision: 003