

PRODUCTPROFILE

Catalogue number: 049A19180M4

Partnumber: 754778

PreCONNECT® TRUNK MULTIJUMPER
12 channels, 24 fibers, 50/125µmOM4, violett
Connector side A: LC-Compact MM
Connector side B: LC-Compact MM
Cable I-B(ZN)BH24G50/125µmJF OM4

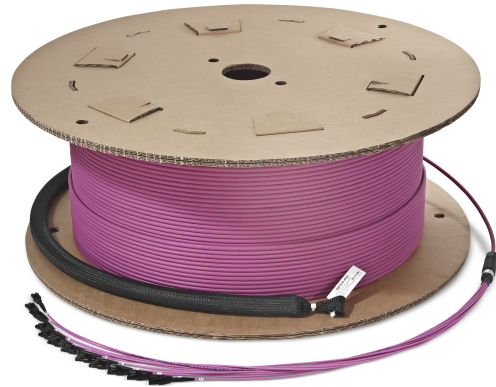

Related documents:

DS_FASER OM4BI_OE	Fiber Data Sheet
DS_I-BZNBHN1500_L_OE	Cable Data Sheet
DS_LC_COMPACT_STECKER_SHORT_C	Steckerdatenblatt
PRECONNECT_TMJ_OE	Product information

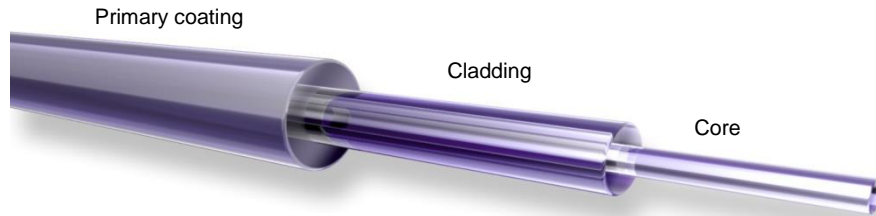

Standards

Graded index fiber 50/125µm according to
 -ISO/IEC 11801 und EN 50173-1 OM4
 -IEC 60793-2-10 type A1a.3
 -ITU G.651.1
 -TIA/EIA 492AAAD

Structure

Silica fiber with two layer acrylate primary coating

Geometrical properties

Core diameter	50 µm +/- 2.5 µm
Cladding diameter	125 µm +/- 1 µm
Core non-concentricity	< 5 %
Cladding non-circularity	< 1 %
Core-Cladding concentricity	< 1.5 µm
Primary coating diameter	242 µm +/- 5 µm
Coating-Cladding concentricity	< 12 µm

Mechanical properties

Break strength SCREEN-Test 1 % strain for 1 s @100 kpsi

Thermal properties

Operating temperature range -60 to +85°C

Dieses Dokument ist urheberrechtlich geschützt • This document is protected by copyright • Rosenberger OSI GmbH & Co. OHG

Transmission characteristics

Attenuation:

@ 850 nm max. 2.3 dB/km
@ 1300 nm max. 0.6 dB/km

Macrobending, induced attenuation:

100 turns, 37.5 mm \leq 0.05 dB @ 850 nm
100 turns, 37.5 mm \leq 0.15 dB @ 1300 nm
2 turns, 15 mm \leq 0.1 dB @ 850 nm
2 turns, 15 mm \leq 0.3 dB @ 1300 nm
2 turns, 7.5 mm \leq 0.2 dB @ 850 nm
2 turns, 7.5 mm \leq 0.5 dB @ 1300 nm

Bandwidth (Overfilled launch):

@ 850 nm min. 3500 MHz x km
@ 1300 nm min. 500 MHz x km

Effective modal Bandwidth-length-product (EMB):

@ 850 nm min. 4700 MHz x km

Numerical aperture: 0.200 +/- 0.015

Effective group index of refraction:

@ 850 nm 1.480
@ 1300 nm 1.479

Backscatter attenuation @ 1ns pulse width:

@ 850 nm -68 dB
@ 1300 nm -76 dB

Maximum possible transmission channels lengths:

Ethernet:

1 GBE 1000BASE-SX: min. 1100 m @ max. 3.56 dB channel attenuation ¹⁾
10 GBE 10GBASE-SR: min. 550 m @ max. 2.60 dB channel attenuation ¹⁾
40 GBE 40GBASE-SR4: min. 170 m @ max. 1.50 dB channel attenuation ¹⁾
100 GBE 100GBASE-SR10: min. 170 m @ max. 1.50 dB channel attenuation ¹⁾

Fibre Channel:

8 GFC (800-SN): min. 245 m @ max. 1.76 dB channel attenuation ¹⁾
16 GFC (1600-SN): min. 165 m @ max. 1.51 dB channel attenuation ¹⁾

¹⁾ Inclusive max. 1.0 dB for connections (connectors and splices)

While the information has been carefully compiled to the best of our knowledge, nothing is intended as representation or warranty on our part and no statement herein shall be construed as recommendation to infringe existing patents. In the effort to improve our products, we reserve the right to make changes judged to be necessary.

Draft	Date	Approved	Date	Rev.	Engineering change number	Name	Date
H. Jungbäck	26-10-15	P. Maier	26-10-15	004	without	H. Jungbäck	26-10-15

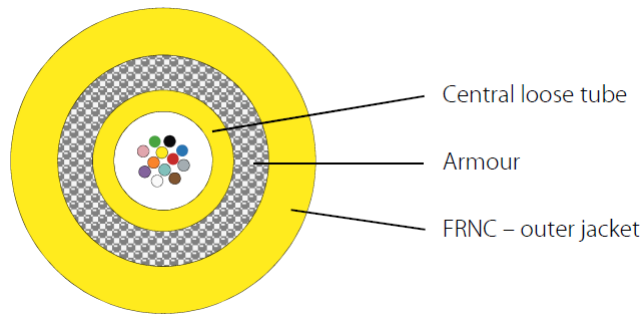

Standards

- IEC 60794-2
- EN 50575:2014 +A1:2016: Number of Declaration of Performance CDERF0000038-V2

Structure

Loose tube:

- Gel-free loose tube: 2 to 12 optical fibers diameter 3.0 mm, 14 to 24 optical fibers diameter 3.5 mm
- Fiber color code 1 to 12: red, green, blue, yellow, white, grey, brown, violet, turquoise, black, orange, pink
- Fiber color code 13 to 24: red, green, blue, yellow, white, grey, brown, violet, turquoise, transparent, orange, pink, all with black ring-marking

Armor:

Multifunctional, reinforced E-glass yarns, wrapped in two layers (left and right spin), as strain relief elements and non-metallic rodent protection

Outer jacket:

- FRNC-LSZH flame-retardant and halogen-free material
- Standard jacket colors:
 - Singlemode: yellow
 - Multimode OM2: orange or green
 - Multimode OM3: aqua (turquoise)
 - Multimode OM4: violet
- Wall thickness 1.0 mm
- Inkjet marking black acc. to separate drawing

Geometrical properties

Number of fibers	Outer diameter [mm]	Weight [kg/km]	Fire load [MJ/m]
12	6.5	46	0.62
24	7.0	51	0.68

Mechanical properties

- Min. bending radius fixed (static) acc. IEC 60794-1-2 E11A
15 x outside diameter
- Min. bending radius during installation (dynamic) with additional tensile strain acc. IEC 60794-1-2 E6
20 x outside diameter
- Max. tensile force acc. IEC 60794-1-2 E1 = 1500 N
- Max. crush resistance acc. IEC 60794-1-2 E3 long term = 1500 N/dm
- Impact resistance acc. IEC 60794-1-2 E4 = 3 impacts, 2.0 Nm, R = 12.5 mm

Thermal properties

- Transport and storage - 25°C to + 70°C
- Installation - 5°C to + 50°C
- In use acc. IEC 60794-1-2 F1 - 25°C to + 60°C

Chemical properties

No resistance to oil, petrol, acid, leach and water

Fire performance

- Flame-retardant acc. to IEC 60332-1-2 and IEC 60332-3-24 Cat. C
- Smoke density acc. to IEC 61034
- Halogen-free acc. to IEC 60754-1
- Acidity of the combustion gases acc. to IEC 60754-2
- Fire Class according EN 13501-6 B2_{CA}/S1a/d0/a1

Transmission characteristics

See fiber data sheets

Applications

- Through its small diameter and high bending flexibility the cable is particular appropriate for factory assembled Trunks for Data Center cabling.
- By its very good Fire Class and its gel-free mini loose tubes, the cable is perfectly applicable for in-house splice installations too.

Deliveryform

On one-way drums

While the information has been carefully compiled to the best of our knowledge, nothing is intended as representation or warranty on our part and no statement herein shall be construed as recommendation to infringe existing patents. In the effort to improve our products, we reserve the right to make changes judged to be necessary.

Draft	Date	Approved	Date	Rev.	Engineering change number	Name	Date
H. Jungbäck	2017-07-17	P. Maier	2017-07-17	001	without	H. Jungbäck	2017-07-17

LC-COMPACT Shortboot connector

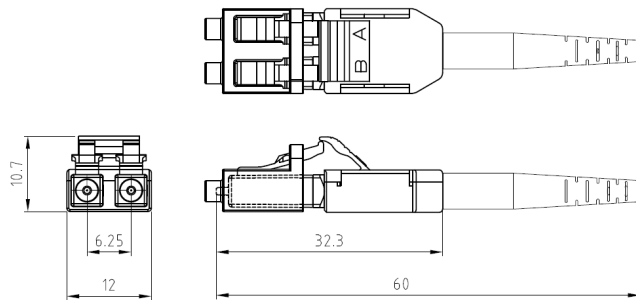

Properties and applications

- LC-Duplex connector with compact and rugged backshell with short central strain relief and boot for round cable (Uniboot)
- A/B polarity can be easily tool-less changed
- The short boot enables the use of the connector in applications with low depth, like ODF Optical Distribution Frames
- Translucence duplex protection cap, fast and secure to handle and permeable for the light of laser pointers (visual fault locators)

Standards

LC-Duplex acc. to IEC/DINEN 61754-20 and EIA/TIA 604-10

Material

- Ferrule: Zirconia ceramic, Ø 1.25 mm
- Body: PEI, flammability UL94-V0
- Boot: TPE, flammability UL94-V0
- Protection cap: POM, flammability UL94-HB

Optical properties

The quality feature of the connector at your product is identified by the part number:

- BASIC: Part numbers like XXXAXXXX
- PURE: Part numbers with "P" at their end, XXXAXXXXP

Details about PURE see Produktinfo_Qualitätsmerkmal-PURE_od

Insertion Loss IL acc. to IEC61300-3-4, Method B, against reference, maximum [dB]:

	Quality feature	BASIC	PURE
- Singlemode SM, 9/125µm		0.30	0.20
- Multimode OM1, 62.5/125µm		0.30	---
- Multimode low IL OM2, OM3, OM4, OM5, 50/125µm		0.15	0.15

Insertion Loss IL „random mated“ acc. to IEC61300-3-34, Method 2, [dB]:

Quality feature	BASIC	mean value	maximum
- Singlemode SM, 9/125µm		0.13	0.50
- Multimode low IL OM2, OM3, OM4, OM5, 50/125µm		0.03	0.27

Insertion Loss IL quality feature PURE "random mated" application limit value, maximum [dB]:

- Singlemode SM, 9/125µm	97%	0.25
- Multimode low IL OM2, OM3, OM4, OM5, 50/125µm	100%	0.40

GHMT PVP certificate
No.: c6997X-XX
No.: c6998X-XX



Dieses Dokument ist urheberrechtlich geschützt • This document is protected by copyright • Rosenberger OSI GmbH & Co. OHG

LC-COMPACT Shortboot connector

Optical properties

Return Loss RL acc. to IEC61300-3-6, Method 1, against reference, minimum [dB]:

	Quality feature	BASIC	PURE
- Singlemode SM, 9/125µm, PC 0°		45	45
- Singlemode SM, 9/125µm, UPC 0°		55	55
- Singlemode SM, 9/125µm, APC 8°		65	70
- Multimode all classes		35	40

Mechanical properties

- Mating cycles min. 1000, IL increase < 0.2 dB
- Strain relief max. 100 N, dependent on cable type

Thermal properties

- Operation temperature range -40°C to +85°C, dependent on cable type
- Storage temperature range -40°C to +85°C

Cable diameters

- Round cable types Ø 2.0 to 3.0 mm

Colors

Connector body / boot:

- Singlemode SM, 9/125µm, PC and UPC 0° blue / blue
- Singlemode SM, 9/125µm, APC 8° green / green
- Multimode OM1, 62.5/125µm beige / white
- Multimode OM2, OM3, OM4, OM5, 50/125µm black / black

Polarity change

1) Remove the connector top cover by inserting a fingernail or a small lever into the crack that separates the two halves.

2) Carefully swap position of the connectors by lifting them up and out of the bottom housing.

3) Reposition the top cover and snap into place.



While the information has been carefully compiled to the best of our knowledge, nothing is intended as representation or warranty on our part and no statement herein shall be construed as recommendation to infringe existing patents. In the effort to improve our products, we reserve the right to make changes judged to be necessary.

Draft	Date	Approved	Date	Rev.	Engineering change number	Name	Date
H. Jungbäck	2018-12-13	A. Burggraf	2018-12-13	009	----	H. Jungbäck	2022-10-07

PreCONNECT® TRUNK MULTIJUMPER

PRODUCT INFORMATION – SHORT VERSION



PreCONNECT® TRUNK MULTIJUMPER solution is available in two end face quality features: BASIC and PURE**Define the end-face quality according to your application requirements:**

Quality feature BASIC is our well-proven, high-grade, standards compliant product in terms of end-face geometry, defect, and cleanliness, providing excellent IL and RL performance:

1. The PreCONNECT® factory-assembled plug & play system enables quick and reliable, cost efficient, installation and performance
2. Harmonized modular components of the quality feature BASIC solution ensure end to end performance of the entire channel

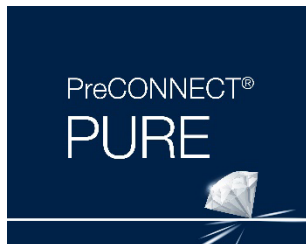

Quality feature PURE is the enhanced version of our quality feature BASIC, but with more stringent defect and cleanliness screening and factory sealed, tamper evident adapter-interfaces.

3. Guaranteed protection of the polished connector end-face against contamination and damage through sealed adapter-interfaces, enabling time savings during initial installation and commissioning due to the elimination of the need for cleaning and testing*/**.
4. Quality feature PURE provides an industry leading low random mate insertion and return loss (mean) which enables up to six (6) mated pairs in a 10G/OM4 application up to 300m.

Part numbers:

Quality feature BASIC: The part numbers XXXAXXXX listed in this document are valid for the BASIC quality feature.

Quality feature PURE: Add a “P” to the end of the quality feature BASIC part number (*Example: XXXAXXXXP*)

(Note: PURE trunk cables have factory attached sealed coupling adapters incorporated and thus utilize empty patch panels and enclosures)

** While Rosenberger does not require permanent link or channel testing for warranty registration of PURE installations due to guaranteed performance, certain customers will require testing documentation for their records.*

*** Only applicable when all components are of quality feature PURE and installed by trained PURE installers.*

Applications:

Cabling of large switches and floor-standing IT hardware within data centers, to represent their ports in a patch location

System consists of:

- Factory assembled FO loose tube cables, FRNC-LSZH indoor and universal cables, up to 144 fibers
- With connector systems LC, SC, E2000® and MTP® at application specific leg-lengths

Features:

- Representation of IT hardware ports in a patch locations
- Lengths of the connector legs can be ordered application specific

Your benefits at a glance:

- Cost reduction through direct attach of the IT Hardware Transceivers the TMJ connector legs
- Attenuation reduction through the saving of one connection in the transmission channel
- Application specific individually configurable
- Fast and safe installation through factory assembled Plug & Play systematic
- Highest quality and cost-efficiency through factory assembling
- PreCONNECT® cabling systems consist of perfectly harmonized modular single components



Applications:

Cabling of large switches and floor-standing IT hardware within data centers, to represent their ports in a patch location.

- **Trunk multijumper up to 144 fibers per Trunk**
- **Cost and attenuation optimized**
- **Focused on the useful and necessary**

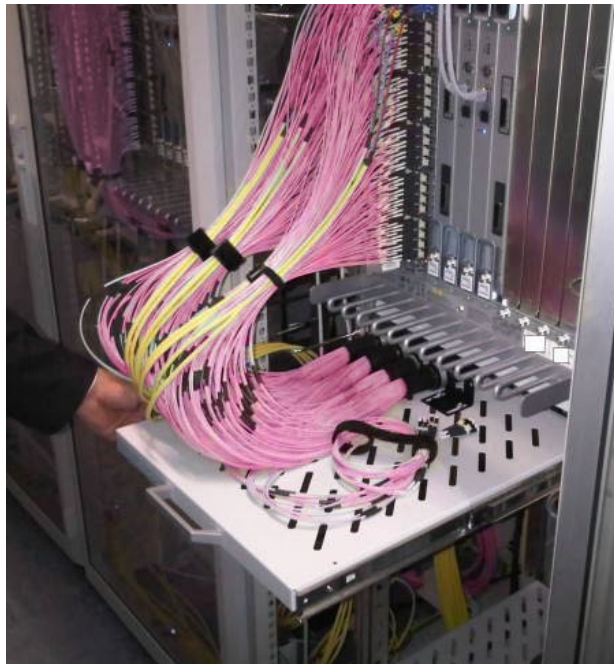

System description:

Our PreCONNECT® TRUNK MULTIJUMPER cabling system consists of:

- Trunk multijumper TMJ called factory assembled FO loose tube cables up to 144 fibers, can be ordered with application specific „variable“ long connector legs:
 - Duplex connectors at 2x2.1 mm Zipcord fanouts, leg lengths up to max. 3 m possible
 - Compact connectors at 2,9 mm round fanouts, leg lengths up to max. 5 m possible
- Cable Divider Drawer, to be mounted below the switch to install the TMJ Cable Dividers
- a large variety of patchcords and accessories
- and Patch Location Racks

TMJ types with hybrid connector legs, „standard stepped“ at the patch location side A, fitting for the explicitly therefor developed 19” Panel systems, and leg lengths fitting for the to be attached hardware at side B, is the most common application case.

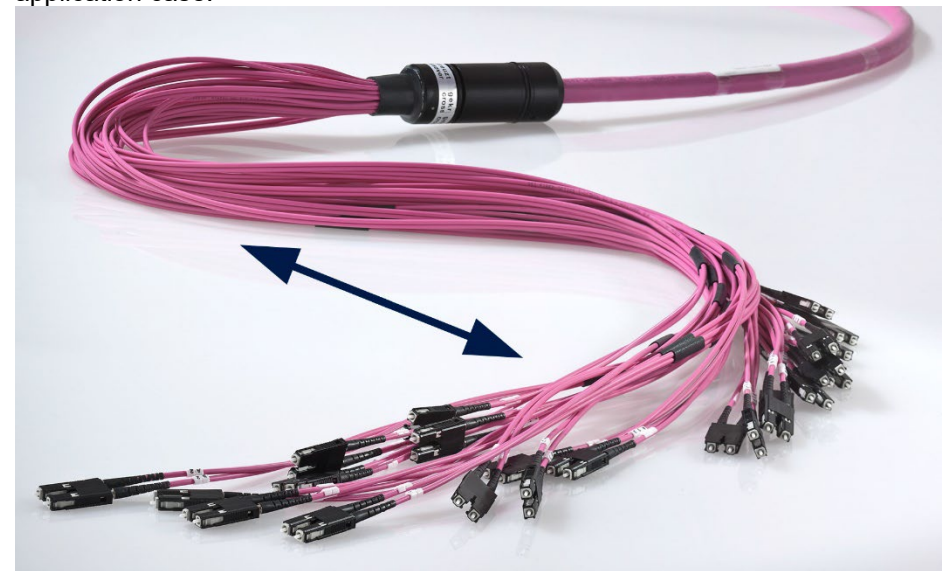

Properties:

Both cable ends of the PreCONNECT® TRUNK MULTIJUMPER are molded within the cable dividers. Rosenberger OSI brought already 1991 high fibercount factory assembled FO Trunk cables to the market. PreCONNECT® STANDARD was the first in Europe developed and manufactured, high fibercount and modular „Plug-and-Play“ FO cabling system.

The PreCONNECT® cable divider is a splice-less furcation to separate the fibers of loose tube cables. He is one of the mechanically and thermally most robust cable dividers for loose tube cables at smallest diameters. With its integrated PreCONNECT® square interface, the cable divider can be tool-less hooked into PreCONNECT® Panels for tensile and torsion resistant fixing of the Trunks.

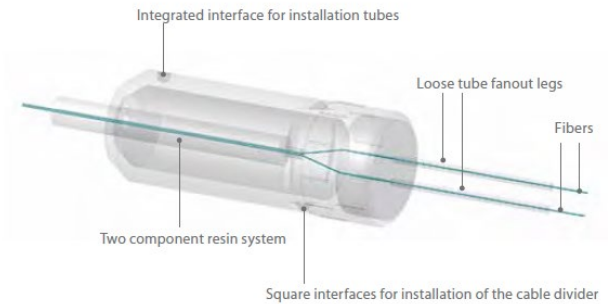

Coding/polarity: The connector legs are alpha numerical uniquely coded. The standard polarity is „channelwise crossed“ (pairwise flipped) for full-duplex transmission systems – A1 to B1, A2 to B2, etc. On request „uncrossed“ deliverable.

Installation protection: The package of application specific „variable“ legs is a not pull resistant dust-proof foil tube.



On „standard stepped“ legs you can select:

- dust-proof foil tube
- and 600 N tensile-strength, crush and kink resistant, IP50 dust-proof indoor-installation-tube



Length definition:

- Order-length = length between the connectors of the longest legs at both sides, not between the PreCONNECT® cable dividers.
- Possible order-lengths: From 5 to 2000 meter

Length tolerances:

Trunk length	Tolerance
<= 10m	+/- 50cm
> 10m <= 30m	+/- 100cm
> 30m <= 100m	+/- 150cm
> 100m	+/- 2%

Delivery form: Dependent on the length as cable ring or on cardboard or wooden drum, 100% IL factory measured with measurement protocol, installation manual, product label with serial number on both sides.

Properties:

Trunk cable types:

PreCONNECT® TRUNK MULTIJUMPER are deliverable with all common loose tube cables up to 144 fibers, mostly used:

- Indoor cable I-B(ZN)BH, CPR class B2ca
 - Universal cable U-DQ(ZN)BH, CPR class Dca or Cca dependent on stock
- Cable data, see separate cable data sheets.

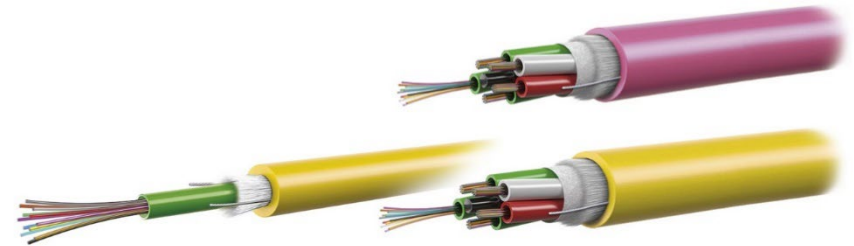

Fiber types:

With all common fiber types deliverable.
 Bend-insensitive fibers by default.
 Fiber data, see separate fiber data sheets.

Connector types:

With all common connector types deliverable.
 Connector data, see separate connector data sheets.

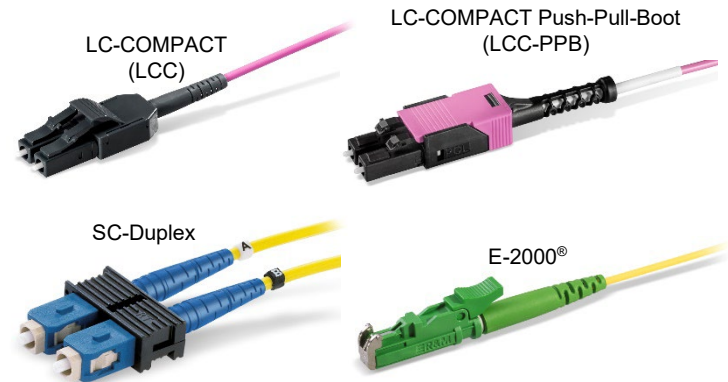

With MTP® OCTO 4+4 fiber and DUODECIM 12 fiber on request



PreCONNECT® TRUNK MULTIJUMPER
with indoor cable I-B(ZN)BH, CPR class B2ca:



With application specific „variable“ long connector legs:

- Duplex connectors at 2x2.1 mm Zipcord fanouts, leg lengths up to max. 3 m possible
- Compact connectors at 2,9 mm round fanouts, leg lengths up to max. 5 m possible

Part numbers				
Channels/Fibers	Connectors on both sides	SM PC 0	SM APC 8°	OM4
4/8	LC-COMPACT	049A1928G657A1	on request	049A1927OM4
6/12	LC-COMPACT	049A1909G657A1	049A1908G657A1	049A1917OM4
12/24	LC-COMPACT	049A1926G657A1	049A1938G657A1	049A1918OM4
16/32	LC-COMPACT	049A0849G657A1	on request	049A1916OM4
24/48	LC-COMPACT	049A1902G657A1	049A1937G657A1	049A1912OM4
32/64	LC-COMPACT	on request	on request	049A1910OM4
36/72	LC-COMPACT	049A1903G657A1	on request	049A1913OM4
48/96	LC-COMPACT	049A1904G657A1	on request	049A1914OM4
64/128	LC-COMPACT	049A1958G657A1	on request	049A1964OM4
72/144	LC-COMPACT	049A1959G657A1	on request	049A1915OM4

Technical data of connectors, fibers and cables on request via the product profile of your selected trunk multijumpers.

About Rosenberger OSI:

Since 1991, Rosenberger Optical Solutions & Infrastructure (Rosenberger OSI) has been a recognized expert for fiber-based connectivity, cabling solutions and infrastructure services in the areas of data centers, local area networks, mobile networks and industrial applications. As an integrated solution provider, we have high expertise in the development and operational excellence in the production of system solutions for communication networks. Our comprehensive services enable the secure and efficient operation of digital infrastructures. This combination, combined with our strong customer focus, makes us unique and a strong partner in the global market.

Rosenberger OSI has been part of the globally operating Rosenberger Group since 1998. The Rosenberger Group is a leading global provider of high-frequency, high-voltage and fiber optic connectivity solutions with headquarters in Germany. For further information, please visit:

www.rosenberger.com/osi

Rosenberger

Rosenberger-OSI GmbH & Co. OHG

Optical Solutions & Infrastructure | Endorferstr. 6 | 86167 Augsburg | GERMANY | Telephone: +49 821 24924-0
info-osi@rosenberger.com | www.rosenberger.com/osi

Rosenberger® is a registered trademark of Rosenberger Hochfrequenztechnik GmbH & Co. KG. All rights reserved. © Rosenberger 2022

For technical reasons, we reserve us the right to make any deviations from the illustrations in the product information.
Transfer to third party only by authority of Rosenberger-OSI GmbH & Co. OHG- All rights reserved.

Creation date: 2021-08-23

Valid since: 2022-10-06

Revision: 002