

PRODUCTPROFILE

Catalogue number: 170H2103

Partnumber: 776050

SMAP-G2 HD Part-Front-Plate 1/3HU-1/6
with 4 MTP (2xMTPD) SM-APC green Typ A
opposed keys adapters
RAL9005 black
numbering 01-04



Related documents:

PRECONNECT_SMAP-G2-HD_OE

Produktinformation

PreCONNECT® SMAP-G2 Smart Panel Generation 2 High Density (HD) 19" panel system

PRODUCT INFORMATION



Rosenberger OSI offers with PreCONNECT® SMAP-G2 HD a highly modular and plastic-reduced 19“ Smart Panel SMAP panel system for data center data cabling.

With a port density up to 72 LC-Duplex or MTP® ports, or 144 MDC ports per height unit a very high utilization of the front surface is achieved. A service-friendly assembly of the PFP's or the MTP® module cassettes is possible without tools by quick fasteners. Also the proven PreCONNECT® square-interface enables a toolless fixing of the trunk cables.

Depending on the type of use and assembly of the PreCONNECT® SMAP-G2 HD panels, a multitude of easily exchangeable back planes are available for cable interception. The PreCONNECT® SMAP-G2 HD panel is depth-adjustable by 19" mounting brackets and can therefore be individually adapted to different rack conditions.

Properties:

- Port density: 72 LC-Duplex or MTP® ports, or 144 MDC ports per height unit HU
- Consists of 1 HU and 2 HU empty panels in three different width partitions 6/6, 4/4 and 3/3
- Empty panels are to be equipped with 1/3 HU part front plates PFPs and MTP® module cassettes in 1/6, 1/4 and 1/3 width partitions
- PFPs and cassettes are toolless inserted from the front side and fixed with quick fasteners
- PFPs and cassettes can be pulled out to the front for maintenance
- Through its adjustable 19“ mounting brackets the panel can be depth variable mounted
- Trunk cables can be routed into the panels through their back planes and either side
- At panels with trunk routing through their back planes, which are not fully equipped during their first installation, trunk cables can be retrofitted afterwards and removed for maintenance

Applications:

- Panel system for data center data cabling
- For all IT applications like Ethernet and Fibre Channel
- Appropriate for Spine-Leaf architectures, by default 12, optional up to 16 trunks coming from Leaf Switches can be accommodated per HU within SMAP-G2 distribution panels next to the Spine-Switch

Your benefits at a glance:

- High modularity to configure individual cabling structures
- Fast and easy handling during first installation, retrofit and maintenance, one-man installation possible
- Low complexity, focused on the functional needs
- Simple and low-cost migration to other applications, e.g. from duplex technology to MTP® based Parallel Optics
- Fiber and copper data cabling can be installed together within one panel
- Low fire load through minimized use of plastic

PreCONNECT® SMAP-G2 High Density (HD) 19" panel system:

Is the High Density (HD) variant of the generation 2 of our since years proved and tested, highly modular and plastics reduced 19" Smart Panel SMAP system for data center data cabling.

Port density: 72 LC-Duplex or MTP® ports, or 144 MDC ports per height unit HU

PreCONNECT® SMAP-G2 HD consists of 1 HU and 2 HU empty panels in three different width partitions 6/6, 4/4 and 3/3.

The Empty panels are to be equipped with 1/3 HU part front plates PFPs and MTP® module cassettes in 1/6, 1/4 and 1/3 width partitions (1).

The PFPs and cassettes are toolless inserted from the front side and fixed with quick fasteners. By this design they can be pulled out to the front for maintenance.

The modular panel back planes (2) offering highest flexibility to configure cable entries application specific easy and cost-saving. See the configurations of the back planes in the descriptions of the empty panels.

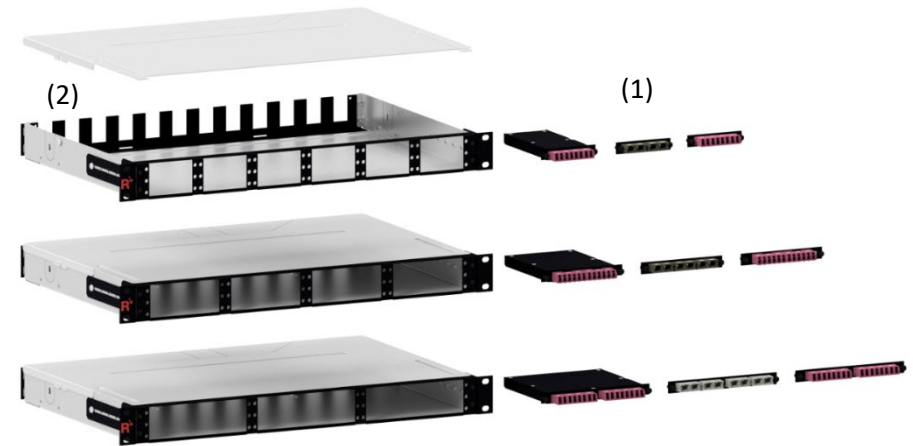

Front granularity 6/6 width partition

1	4	7	10	13	16
2	5	8	11	14	17
3	6	9	12	15	18

Front granularity 4/4 width partition

1	4	7	10
2	5	8	11
3	6	9	12

Front granularity 3/3 width partition

1	4	7
2	5	8
3	6	9

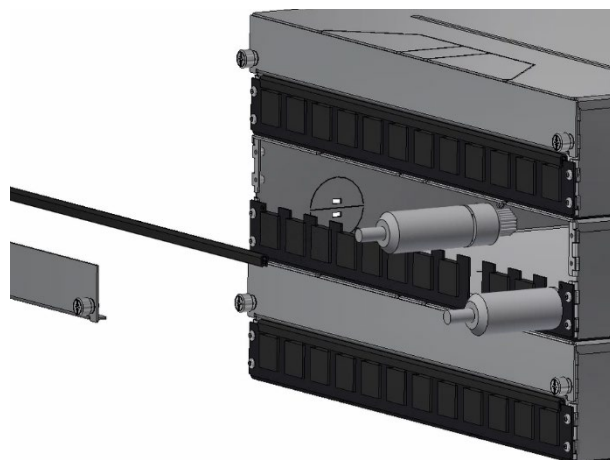

Back plane blind covers at 2, 3 and 5 HU panels can be removed by their captive screws for comfortable trunk cable retrofit and maintenance.

The back plane of the 1 HU panel can be removed for retrofit and maintenance of trunk cables.

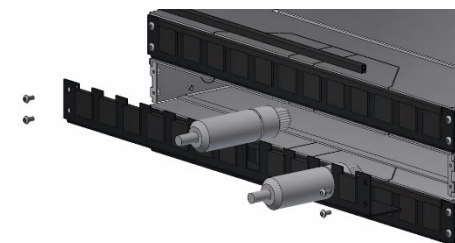

PreCONNECT® SMAP-G2 High Density (HD) 19” panel system:

Material and colour:

- Panel body: aluminum silver
- 19” mounting brackets and front: steel powder coated RAL9005 black

Weight: One of the lowest weight panels of its kind: 1 HU empty distribution panel 1.6 kg

Dimensions:

- Width: 19“
- Height: 1 HU and 2 HU
- Depth: 200 mm and 300 mm. Through the captive screws of their back plane blind covers, the 2, 3 and 5 HU panels are 212 mm and 312 mm deep. We recommend 300 mm as shown here, because the space to accommodate trunk cable dividers and connector legs is enough, but uncomfortable narrow within 200 mm deep panels.

Part numbers:

SMAP-G2 UHD 19“ empty distribution panels, RAL9005 black, back plane with 12 PreCONNECT® square interfaces, as shown here. PreCONNECT® square interfaces dustproof covered with tool less removable blanks, here not shown.

1 HU, 6/6 width partition, depth 300 mm	171H0013
1 HU, 4/4 width partition, depth 300 mm	171H0010
1 HU, 4/4 width partition, depth 200 mm	171H0001
1 HU, 3/3 width partition, depth 300 mm	171H0015
2 HU, 4/4 width partition, depth 300 mm	172H0002
2 HU, 4/4 width partition, depth 200 mm	172H0001

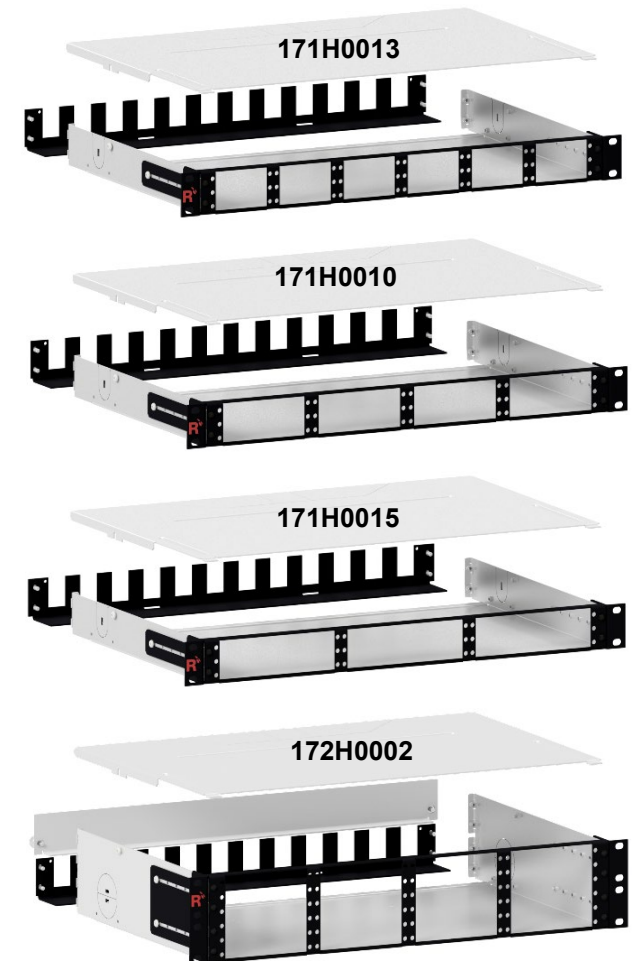

PreCONNECT® SMAP-G2 SD 19" panel system:

Through their adjustable 19" mounting brackets, the panels can be stepless mounted to protrude to the front over the 19" level (Position A), or to stay recessed behind it (Position B).

Position	panel depth	X [mm]	Y [mm]
A: protrusion to the front, over the 19" level	200 mm	160	40
	300 mm	225	75
B: recessed behind the 19" level	200 mm	155	45
	300 mm	255	45

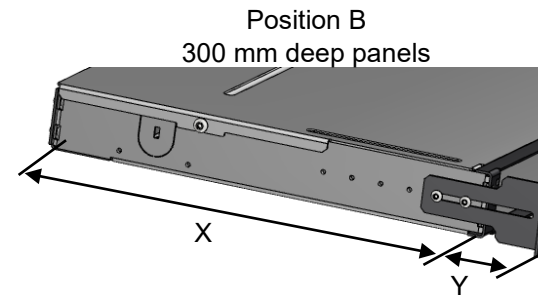
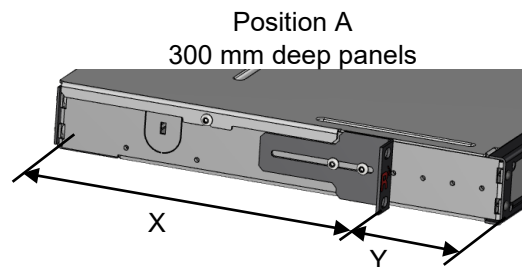
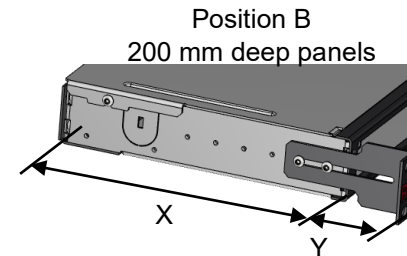
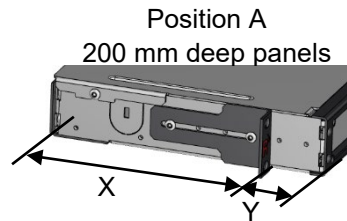

Through the captive screws of their back plane blind covers, the 2, 3 and 5 HU panels are 212 mm and 312 mm deep. This must be considered at position A in particular, because the panels in these cases need X + 12 mm more depth space.

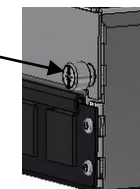

PreCONNECT® SMAP-G2 High Density (HD) 19” panel system:

Part numbers:

SMAP-G2 HD 19” empty distribution panels, RAL9005 black, with diverse back planes:

Configurations	6/6 width partition	4/4 width partition	3/3 width partition
1 HU, depth 300 mm, with modular back plane 2x3 170A1520	171H0014	171H0002	171H0016
1 HU, depth 300 mm, with modular back plane 4x1 170A1521	171A0025	171H0003	171H0017
See these back plane types separate in our product information SMAP-G2 SD.			

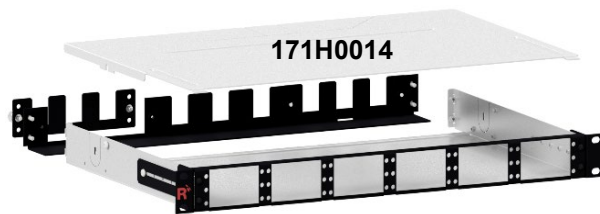

Comfortable trunk cable retrofit
and maintenance in 1 HU panels
Example: modular back plane 4x1 170A1521

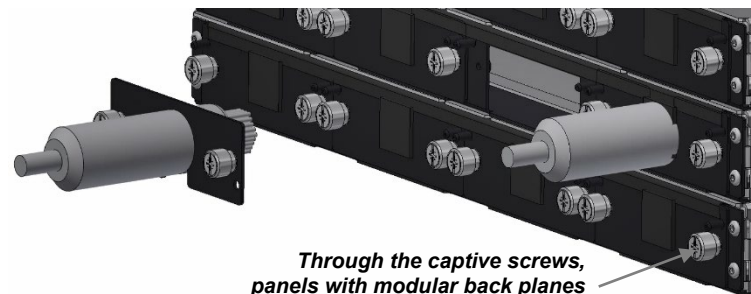

*Through the captive screws,
panels with modular back planes
are 212 mm and 312 mm deep*

PreCONNECT® SMAP-G2 High Density (HD) 19” panel system:

Part numbers:

SMAP-G2 HD 19” empty distribution panels, RAL9005 black, with diverse back planes:

Configurations	6/6 width partition	4/4 width partition	3/3 width partition
1 HU, depth 300 mm, with blind back plane 170A1501 and two trunk cable divider holders 170A1523 to route one trunk cable each through either side of the panel	171H0026	171H0004	171H0018



At 1, 2 and 3 HU panels, one trunk cable each can be routed into the panel at either side through to quarry out perforations (1) and can be fixed within internal trunk cable divider holders (2), which can be mounted within the panels.

This trunk side entry can't be applied at panels equipped with MTP® module cassettes.

(2) internal trunk cable divider holder for 1, 2 and 3 HU, can be ordered as accessory part number: 170A1523

Mounted within 1 HU 200mm



(1) to quarry out perforation

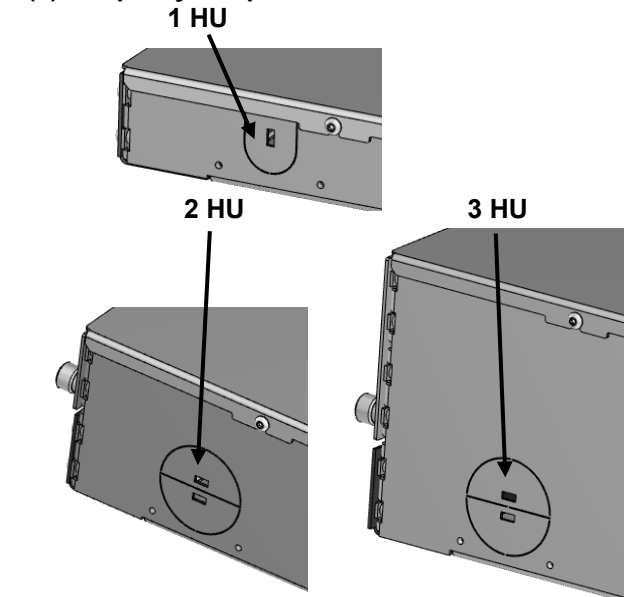

PreCONNECT® SMAP-G2 HD 19" panel system:

To rout patchcords through the side walls into the 1, 2 and 3 HU panels, the universal cable strain relief (1) is available.

**(1) universal cable strain relief for 1, 2 and 3 HU
part number: 170A1526**

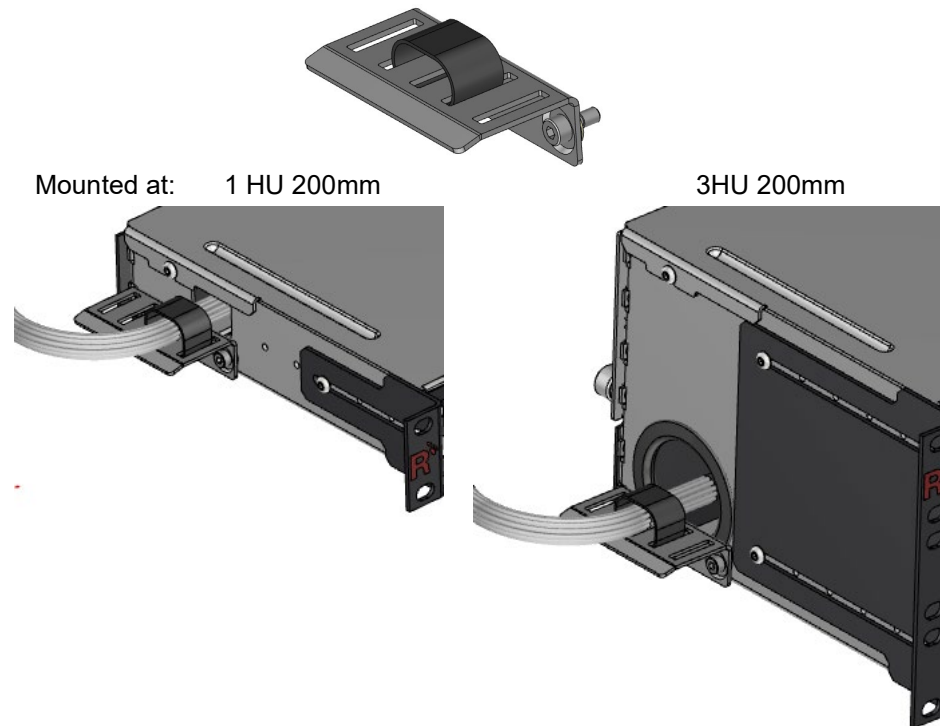

We recommend to apply PreCONNECT® STANDARD trunks with LC-COMPACT Push-Pull-Boot (LCC-PPB) connectors in SMAP-G2 HD panels with part front plates with LC adapters, as described in the product information PreCONNECT® STANDARD.

LC-COMPACT Push-Pull-Boot (LCC-PPB) and MDC patchcords with cable diameter 2.0 mm or thinner must be used with this panel system.

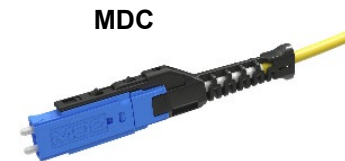

 Patchcord part numbers Duplex Patchcord cable type round I-V(ZN)H FRNC-LSZH					
Cable diameter	Connectors	Lenght	OM4	SM PC 0°	SM APC 8°
1.6 mm	LC-COMPACT PPB » LC-COMPACT PPB	variable	087A6949OM4	087A6948G657A1	087A6950G657A1
	MDC » LC-COMPACT PPB	variable	092A0012OM4	092A0011G657A1	on request
	MDC » MDC	variable	092A0010OM4	092A0009G657A1	on request
2.0 mm	LC-COMPACT PPB » LC-COMPACT PPB	variable	087A6737OM4	087A6738G657A1	087A6747G657A1
	MDC » LC-COMPACT PPB	variable	092A0008OM4	092A0007G657A1	on request
	MDC » MDC	variable	092A0004OM4	092A0003G657A1	on request
double jacket 2.0 / 4.0 mm	LC-COMPACT PPB » LC-COMPACT PPB	variable	on request	on request	on request
	MDC » LC-COMPACT PPB	variable	on request	on request	on request
	MDC » MDC	variable	on request	on request	on request

SMAP-G2 HD 1/3 HU 1/6 part front plates with matrix numbering:

Fitting into SMAP-G2 HD empty panels with 6/6 width partition. The PFPs are toolless inserted from the front side and fixed with quick fasteners. By this design they can be pulled out to the front for maintenance.

The numbering of the part front plates PFP is a modular numerical matrix. The LC-Duplex and MTP® ports within the PFPs have a fixed 1 to 4 labeling.

The PFPs can be numbered with their positions they have within the panels with the exchangeable numbering clips the panels are shipped with.

Material and colour: steel powder coated RAL9005 black

1/3 HU 1/6 Blind PFP

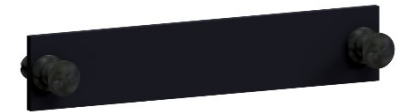

1/3 HU 1/6 PFP 4 LC-Duplex (1 LC8)



1/3 HU 1/6 PFP 4 MTP® (2 MTPD)



1/3 HU 1/6 PFP 4 MTP® 16 MM APC 8° (2 MTPD)



1/3 HU 1/6 PFP 4 MTP® 16 SM APC 8° (2 MTPD)



Part numbers RAL9005 black						
Number of adapter type/fibers	for fiber type					
	SM PC 0° blue	SM APC 8° green	OM4 violet	MM grey	MTP® 16 MM APC 8° white for SEDECIM	MTP® 16 SM APC 8° green for SEDECIM
Blind PFP	170H0002					
4 LC-Duplex (1 LC8) / 8F	170H2100	170H2101	170H2102OM4	---	---	---
4 MTP® (2 MTPD)	---	type A "opposed key" 170H2103	---	type B "aligned key" 170H2104TB	type A "opposed key" 170H2105	type A "opposed key" 170H2106

With other adapter types on request.

SMAP-G2 HD panels factory assembled, 300mm deep, with 1/3 HU 1/6 part front plates with matrix numbering and back plane with 12 PreCONNECT® square interfaces:

Part numbers RAL9005 black				
HU	Number of PFP and type	Number of LC-Duplex ports	SM PC 0° blue	OM4 violet
1	18 x 1/3 HU 1/6 4 LCD	72	171H1000	171H1001OM4
HU	Number of PFP and type	Number of MTP® Ports	SM APC 8° green type A "opposed key"	MM grey type B "aligned key"
1	18 x 1/3 HU 1/6 4 MTP®	72	171H1002	171H1003TB

Other HU and configuration on request.



SMAP-G2 HD 1/3 HU 1/4 part front plates with matrix numbering:

Fitting into SMAP-G2 HD empty panels with 4/4 width partition. The PFPs are toolless inserted from the front side and fixed with quick fasteners. By this design they can be pulled out to the front for maintenance.

The numbering of the part front plates PFP is a modular numerical matrix. The LC-Duplex and MTP® ports within the PFPs have a fixed 1 to 6 labeling.

The PFPs can be numbered with their positions they have within the panels with the exchangeable numbering clips the panels are shipped with.

Material and colour: steel powder coated RAL9005 black

1/3 HU 1/4 PFP 6 LC-Duplex (1 LC12)

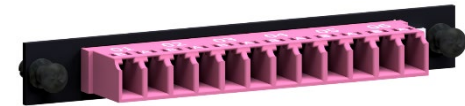

1/3 HU 1/4 PFP 6 MTP® (3 MTPD)



1/3HU 1/4 Blind PFP



Part numbers RAL9005 black				
Number of adapter type/fibers	for fiber type			
	SM PC 0° blue	SM APC 8° green	OM4 violet	MM grey
Blind PFP	170H0001			
6 LC-Duplex (1 LC12) / 12F	170H2000	170H2001	170H2002OM4	---
6 MTP® (3 MTPD)	---	type A “opposed key” 170H2023	---	type B “aligned key” 170H2013TB

With other adapter types on request.

SMAP-G2 HD panels factory assembled, 300mm deep, with 1/3 HU 1/4 part front plates with matrix numbering and back plane with 12 PreCONNECT® square interfaces:

Part numbers RAL9005 black				
HU	Number of PFP and type	Number of LC-Duplex ports	SM PC 0° blue	OM4 violet
1	12 x 1/3 HU 1/4 6 LCD	72	171H3001	171H3000OM4
2	24 x 1/3 HU 1/4 6 LCD	144	172H3003	172H3002OM4
HU	Number of PFP and type	Number of MTP® ports	SM APC 8° green type A “opposed key”	MM grey type B “aligned key”
1	12 x 1/3 HU 1/4 6 MTP®	72	171H3002	171H3003OM4

Other HU and configuration on request.



SMAP-G2 HD 1/3 HU 1/3 part front plates with matrix numbering:

Fitting into SMAP-G2 HD empty panels with 3/3 width partition. The PFPs are toolless inserted from the front side and fixed with quick fasteners. By this design they can be pulled out to the front for maintenance.

The numbering of the part front plates PFP is a modular numerical matrix. The LC-Duplex and MTP® ports within the PFPs have a fixed 1 to 8 labeling.

The PFPs can be numbered with their positions they have within the panels with the exchangeable numbering clips the panels are shipped with.

Material and colour: steel powder coated RAL9005 black

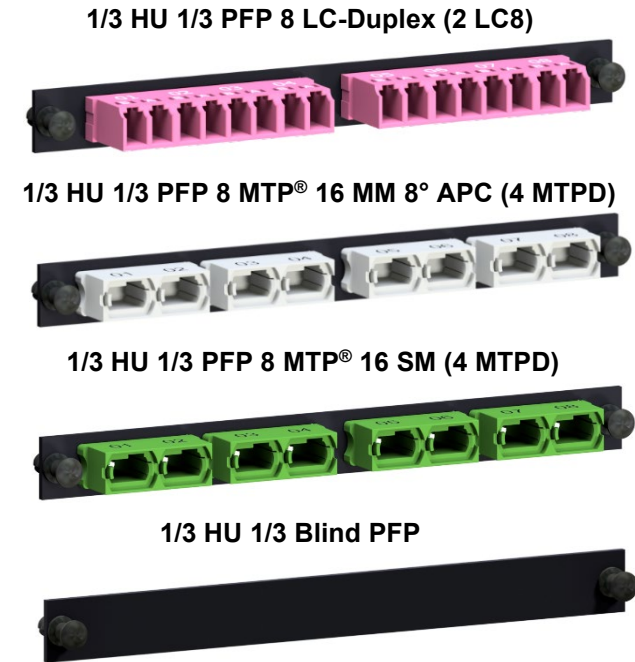

Part numbers RAL9005 black				
Number of adapter type/fibers	for fiber type			
	SM PC 0° blue	SM APC 8° green	OM4 violet	MM white
Blind PFP	170H0003			
8 LC-Duplex (2 LC8) / 16F	170H2202	170H2203	170H2200OM4	---
8 MTP® 16 MM 8° APC type A “opposed key” (4 MTPD)	---	---	---	170H2201
8 MTP® 16 SM type A “opposed key” (4 MTPD)	---	170H2204	---	---

With other adapter types on request.

SMAP-G2 HD panels factory assembled, 300mm deep, with 1/3 HU 1/3 part front plates with matrix numbering and back plane with 12 PreCONNECT® square interfaces:

HU	Number of PFP and type	Number of LC-Duplex ports	OM4 violet
1	9 x 1/3 HU 1/3 8 LCD	72	171H2000OM4
HU	Number of PFP and type	Number of MTP® ports	MM white
1	9 x 1/3HU 1/3 8 MTP® 16 MM 8° APC type A “opposed key”	72	171H2001

Other HU and configuration on request.



SMAP-G2 HD 8 fiber MTP®-LC module cassettes fitting for PreCONNECT® OCTO Trunks:

Properties:

- For Port-Breakout of PreCONNECT® OCTO trunks with MTP® connectors, as described in the product information PreCONNECT® OCTO
- Fitting in SMAP-G2 HD panel with 6/6 width partition
- Height: 1/3 HU
- Width: 1/6
- Depth: 115 mm
- Polarity: Rx to Tx
- 1x MTP® female port 4+4F OCTO at the rear side:
 - OM4: Elite quality, MTP® adapter type B „aligned key” grey
 - SM: Standard quality, MTP® adapter type A „opposed key” green
- 4 LC-Duplex ports at the front side
- Toolless placement of the module cassettes into the panel from the front side, fixing with quick fasteners
- Material and colour cassette body and front: aluminum powder coated RAL9005 black

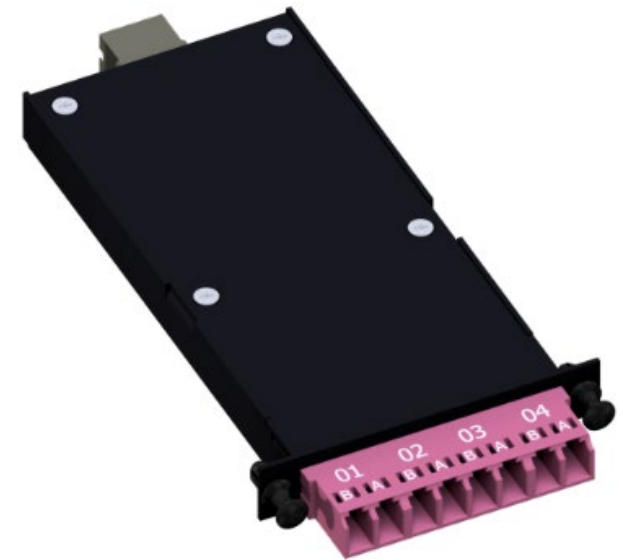

Part numbers RAL9005 black				
Number of 4+4F OCTO MTP® female ports at rear side	Number of LC-Duplex ports at front side	OM4	SM LC-PC 0°	SM LC-APC 8°
1	1 OCTO group of 4 = 4	170H1100OM4	170H1101	on request

SMAP-G2 HD panels factory assembled, 300mm deep, with 1/3 HU 1/6 MTP®-LC module cassettes 1x OCTO and back plane with 12 PreCONNECT® square interfaces:

Part numbers RAL9005 black				
HU	Number of cassettes and type	Number of LC-Duplex ports	OM4	SM LC-PC 0°
1	18 x 1/3 HU 1/6 4 LCD	72	171H1200OM4	171H1201
Other HU and configuration on request.				



SMAP-G2 HD 16 fiber MTP®-MDC module cassettes fitting for PreCONNECT® OCTO trunks:

Properties:

- For Port-Breakout of PreCONNECT® OCTO trunks with MTP® connectors, as described in the product information PreCONNECT® OCTO
- Fitting in SMAP-G2 HD panel with 6/6 width partition
- Height: 1/3 HU
- Width: 1/6
- Depth: 115 mm
- Polarity: Rx to Tx
- 2x MTP® female port 4+4F OCTO at the rear side:
 - OM4: Elite quality, MTP® adapter type B „aligned key” grey
 - SM: Standard quality, MTP® adapter type A „opposed key” green
- 8 MDC ports at the front side
- Toolless placement of the module cassettes into the panel from the front side, fixing with quick fasteners
- Material and colour cassette body and front: aluminum powder coated RAL9005 black



Part numbers RAL9005 black			
Number of 4+4F OCTO MTP® female ports at rear side	Number of MDC ports at front side	OM4	SM MDC-PC 0°
2	2 OCTO groups of 4 = 8	170H1106OM4	170H1105

SMAP-G2 HD panels factory assembled, 300mm deep, with 1/3 HU 1/6 MTP®-MDC module cassettes 1x OCTO and back plane with 12 PreCONNECT® square interfaces:

Part numbers RAL9005 black				
HU	Number of cassettes and type	Number of MDC ports	OM4	SM LC-PC 0°
1	18 x 1/3 HU 1/6 8 MDC	144	171H1300OM4	171H1302
Other HU and configuration on request.				

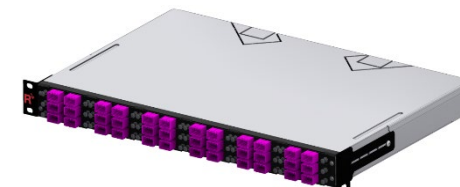

SMAP-G2 HD 16 fiber MTP®-MDC module cassettes fitting for PreCONNECT® SEDECIM trunks:

Properties:

- For Port-Breakout of PreCONNECT® SEDECIM trunks with MTP® connectors, as described in the product information PreCONNECT® SEDECIM
- Fitting in SMAP-G2 HD panel with 6/6 width partition
- Height: 1/3 HU
- Width: 1/6
- Depth: 115 mm
- Polarity: Rx to Tx
- 1 port SEDECIM MTP® 16F female at the rear side:
 - OM4: Elite quality, APC 8°, adapter type A „opposed key” white
 - SM: Elite quality, APC 8°, adapter type A „opposed key” green
- 8 MDC ports at the front side
- Toolless placement of the module cassettes into the panel from the front side, fixing with quick fasteners
- Material and colour cassette body and front: aluminum powder coated RAL9005 black



Part numbers RAL9005 black			
Number of 16F SEDECIM MTP® female ports at rear side	Number of MDC ports at front side	OM4	SM MDC-PC 0°
1	1 SEDECIM group = 8	170H4104OM4	170H4105

SMAP-G2 HD panels factory assembled, 300mm deep, with 1/3 HU 1/6 MTP®-MDC module cassettes 1x SEDECIM and back plane with 12 PreCONNECT® square interfaces:

Part numbers RAL9005 black			
HU	Number of cassettes and type	Number of MDC ports	OM4
1	18 x 1/3 HU 1/6 8 MDC	144	171H1301OM4
Other HU and configuration on request.			



SMAP-G2 HD 12 fiber MTP®-LC module cassettes fitting for PreCONNECT® DUODECIM trunks:

Properties:

- For Port-Breakout of PreCONNECT® DUODECIM trunks with MTP® connectors, as described in the product information PreCONNECT® DUODECIM
- Fitting in SMAP-G2 HD panel with 4/4 width partition
- Height: 1/3 HU
- Width: 1/4
- Depth: 115 mm
- Polarity: Rx to Tx
- 1x MTP® female port 12F DUODECIM at the rear side:
 - OM4: Elite quality MTP® adapter type B „aligned key” grey
 - SM: Standard quality, MTP® adapter type A „opposed key” green
- 6 LC-Duplex ports at the front side
- Toolless placement of the module cassettes into the panel from the front side, fixing with quick fasteners
- Material and colour cassette body and front: aluminum powder coated RAL9005 black

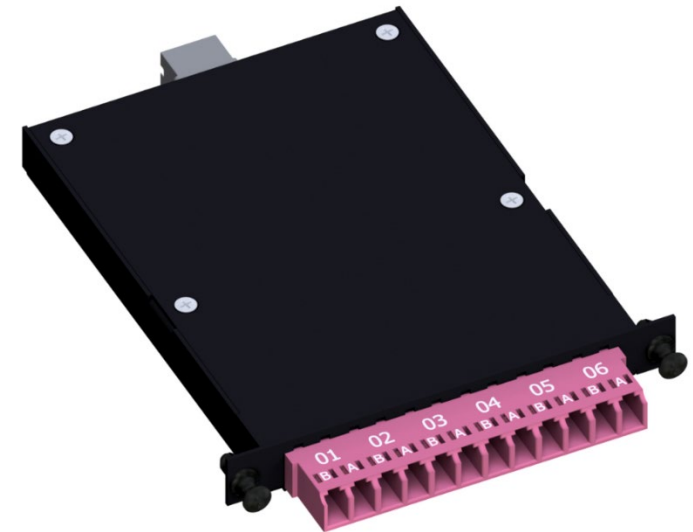

Part numbers RAL9005 black				
Number of 12F DUODECIM MTP® female ports at rear side	Number of LC-Duplex ports at front side	OM4	SM LC-PC 0°	SM LC-APC 8°
1	1 DUODECIM group of 6 = 6	170H1005OM4	170H1004	on request

SMAP-G2 HD panels factory assembled, 300mm deep, with 1/3 HU 1/4 MTP®-LC module cassettes 1x DUODECIM: and back plane with 12 PreCONNECT® square interfaces:

Part numbers RAL9005 black				
HU	Number of cassettes and type	Number of LC-Duplex ports	OM4	SM LC-PC 0°
1	12 x 1/3 HU 1/4 6 LCD	72	171H3200OM4	171H3201
Other HU and configuration on request.				



SMAP-G2 HD 16 fiber MTP®-LC module cassettes fitting for PreCONNECT® SEDECIM trunks

Properties:

- For Port-Breakout of PreCONNECT® SEDECIM trunks with MTP® connectors, as described in the product information PreCONNECT® SEDECIM
- Fitting in SMAP-G2 HD panel with 3/3 width partition
- Height: 1/3 HU
- Width: 1/3
- Depth: 115 mm
- Polarity: Rx to Tx
- 1 port SEDECIM MTP® 16F female at the rear side:
 - OM4: Elite quality, APC 8°, adapter type A „opposed key” white
 - SM: Elite quality, APC 8°, adapter type A „opposed key” green
- 8 LC-Duplex ports at the front side
- Toolless placement of the module cassettes into the panel from the front side, fixing with quick fasteners
- Material and colour cassette body and front: aluminum powder coated RAL9005 black

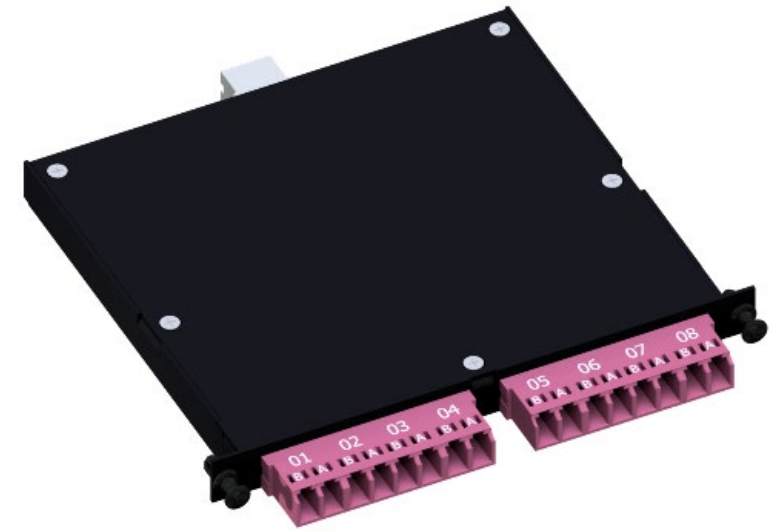

Part numbers RAL9005 black			
Number of 16F SEDECIM MTP® female ports at rear side	Number of LC-Duplex ports at front side	OM4	SM LC-PC 0°
1	1 SEDECIM group = 8	170H1200OM4	170H1202

SMAP-G2 HD panels factory assembled, 300mm deep, with 1/3 HU 1/3 MTP®-LC module cassettes 1x SEDECIM: and back plane with 12 PreCONNECT® square interfaces:

Part numbers RAL9005 black			
HU	Number of cassettes and type	Number of LC-Duplex ports	OM4
1	9 x 1/3 HU 1/3 8 LCD	72	171H2200OM4
Other HU and configuration on request.			



SMAP-G2 HD 32 fiber MTP®-MDC module cassettes fitting for PreCONNECT® SEDECIM trunks

Properties:

- For Port-Breakout of PreCONNECT® SEDECIM trunks with MTP® connectors, as described in the product information PreCONNECT® SEDECIM
- Fitting in SMAP-G2 HD panel with 3/3 width partition
- Height: 1/3 HU
- Width: 1/3
- Depth: 115 mm
- Polarity: Rx to Tx
- 2 port SEDECIM MTP® 16F female at the rear side:
 - OM4: Elite quality, APC 8°, adapter type A „opposed key” white
 - SM: Elite quality, APC 8°, adapter type A „opposed key” green
- 16 MDC ports at the front side
- Toolless placement of the module cassettes into the panel from the front side, fixing with quick fasteners
- Material and colour cassette body and front: aluminum powder coated RAL9005 black



Part numbers RAL9005 black			
Number of 16F SEDECIM MTP® female ports at rear side	Number of MDC ports at front side	OM4	SM MDC-PC 0°
2	2 SEDECIM groups = 16	170H1201OM4	170H1203

SMAP-G2 HD panels factory assembled, 300mm deep, with 1/3 HU 1/3 MTP®-MDC module cassettes 2x SEDECIM: and back plane with 12 PreCONNECT® square interfaces:

Part numbers RAL9005 black			
HU	Number of cassettes and type	Number of MDC ports	OM4
1	9 x 1/3 HU 1/3 16 MDC	144	171H2300OM4
Other HU and configuration on request.			



SMAP-G2 HD 8 fiber MTP®-LC Port-Breakout-Unit

For port-breakout of a MPO4+4 transceiver to 4 LC-Duplex transceivers, without polarity, pin or debris trouble at unit pack plane, lowest attenuation:

Multimode applications:

- 40GBASE-SR4 MPO4+4 to 4x 10GBASE-SR/SW LC-Duplex
- 100GBASE-SR4 MPO4+4 to 4x 25GBASE-SR/SW LC-Duplex
- 200GBASE-SR4 MPO4+4 to 4x 50GBASE-SR/SW LC-Duplex
- 4x16GFC MPO4+4 to 4x 16GFC LC-Duplex
- 4x32GFC MPO4+4 to 4x 32GFC LC-Duplex
- 4x64GFC MPO4+4 to 4x 64GFC LC-Duplex

Singlemode applications:

- 100GBASE-DR4/PSM4 MPO4+4 to 4x 25GBASE-LR LC-Duplex
- 4x10GBASE-LR MPO4+4 to 4x 10GBASE-LR LC-Duplex
- 200GBASE-DR4 MPO4+4 to 4x 50GBASE-LR LC Duplex
- 400GBASE-DR4 MPO4+4 to 4x 100GBASE-LR LC Duplex

Part number:

- Multimode OM4: 170H8000OM4
- Singlemode: 170H8100G657A1

Properties:

- Fitting in SMAP-G2 HD panel with 6/6 width partition
- Height: 1/3 HU
- Width: 1/6
- Depth: 115 mm
- Polarity: Rx to Tx
- 1x MTP®4+4 OCTO female connector at cable pigtail
- 4 LC-Duplex ports at the front side
- Toolless placement of the module cassettes into the panel from the front side, fixing with quick fasteners
- Material and colour cassette body and front: aluminum powder coated RAL9005 black

Recommended empty panel:

SMAP-G2 HD 1 HU, 6/6 width partition, depth 200 mm, capacity: 6x3=18 Port-Breakout-Units, with universal back plane 170A1507, RAL9005 black:

Part number: 171H0033

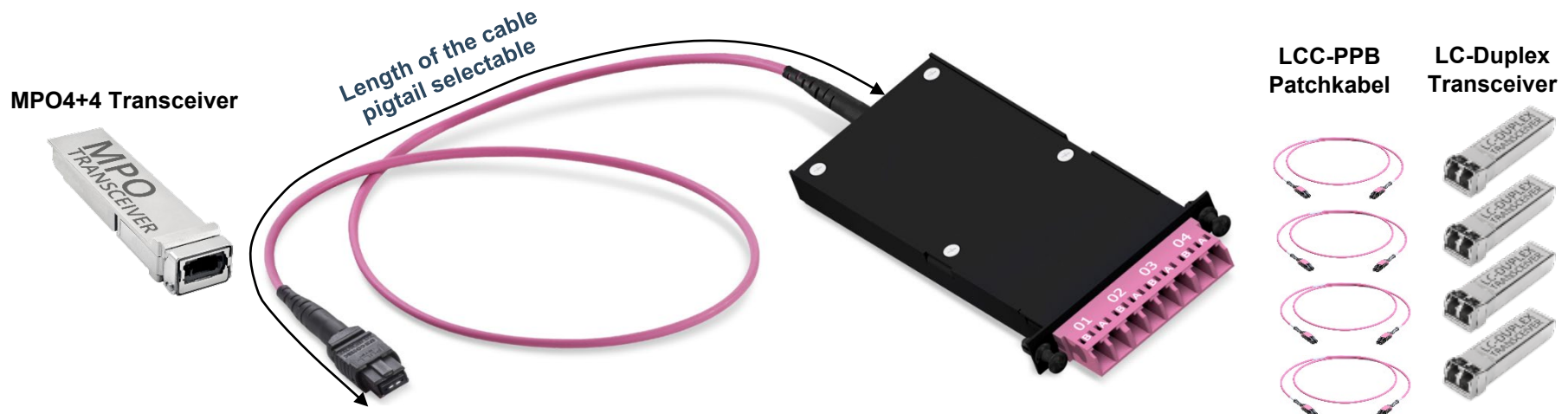
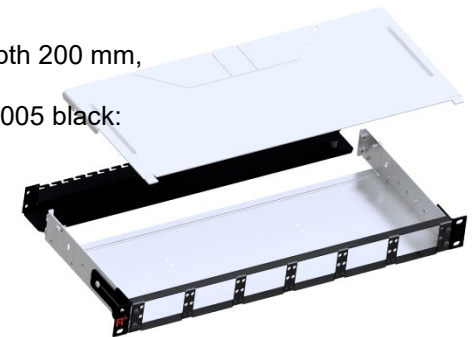

SMAP-G2 HD 16 fiber MTP®-LC Port-Breakout-Unit

For port-breakout of a MPO16 transceiver to 8 LC-Duplex transceivers, without polarity, pin or debris trouble at unit pack plane, lowest attenuation:

Multimode applications:

- 800GBASE-SR8 MPO16 to 8x 100GBASE-SR/SW LC-Duplex

Singlemode applications:

- 800GBASE-DR8/PSM8 MPO16 to 8x 100GBASE-LR LC Duplex

Part number:

- Multimode OM4 with MTP16 female APC 8°: 170H8100OM4
- Multimode OM4 with MTP16 female PC 0°: On request
- Singlemode: 170H8101G657A1

Properties:

- Fitting in SMAP-G2 HD panel with 3/3 width partition
- Height: 1/3 HU
- Width: 1/3
- Depth: 115 mm
- Polarity: Rx to Tx
- 1x MTP®16 SEDECIM female connector at cable pigtail
- 8 LC-Duplex ports at the front side
- Toolless placement of the module cassettes into the panel from the front side, fixing with quick fasteners
- Material and colour cassette body and front: aluminum powder coated RAL9005 black

Recommended empty panel:

SMAP-G2 HD 1 HU, 3/3 width partition, depth 200 mm, capacity: 3x3=9 Port-Breakout-Units, with universal back plane 170A1507, RAL9005 black:

Part number: 171H0034

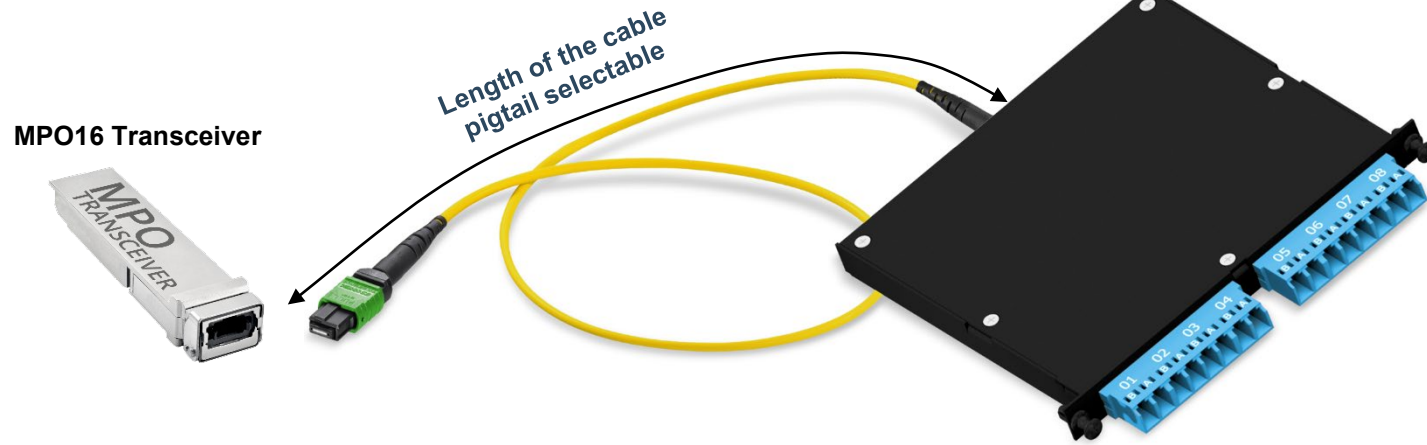

SMAP-G2 HD 6 Port RJ45 Keystone part front plate fitting for PreCONNECT® COPPER trunks with RJ45 Keystone Jacks:

Properties:

- To carry PreCONNECT® COPPER and COPPER ToR-G2 trunks assembled with RJ45 Keystone Jacks, as described in the product information PreCONNECT® COPPER and COPPER ToR-G2
- Fitting in SMAP-G2 HD panel with 4/4 width partition
- For 6 RJ45 Keystone Jacks
- Height: 1 HU
- Width: 1/4
- Toolless placement of the module cassettes into the panel from the front side, fixing with quick fasteners
- Inclusive 2m long grounding cable to connect the PFP, grounding cable is to be routed out of the panel through its back plane and attached at the grounding point of the rack
- Material and colour: steel powder coated RAL9005 black

Part numbers RAL9005 black: 170H7000

PreCONNECT® COPPER and COPPER ToR-G2 trunk



Fixing of PreCONNECT® COPPER trunks at panel back plane using PreCONNECT® universal cable fixture. For cable diameters 6 to 18 mm.

Part number set incl. two cable ties: 111A0650

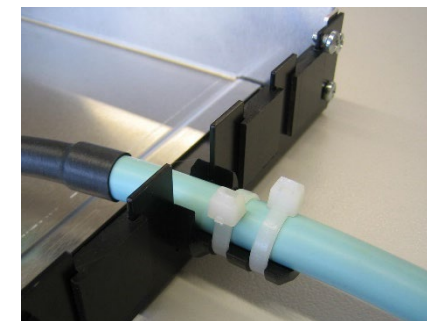
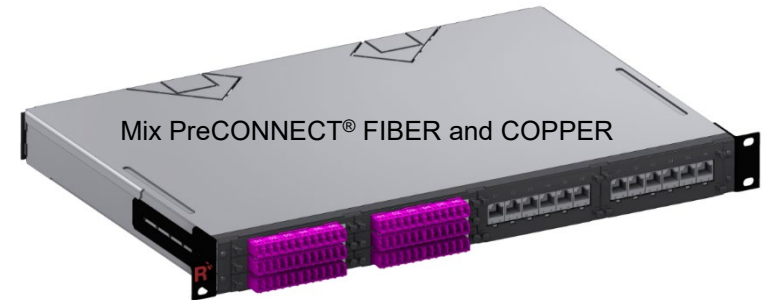
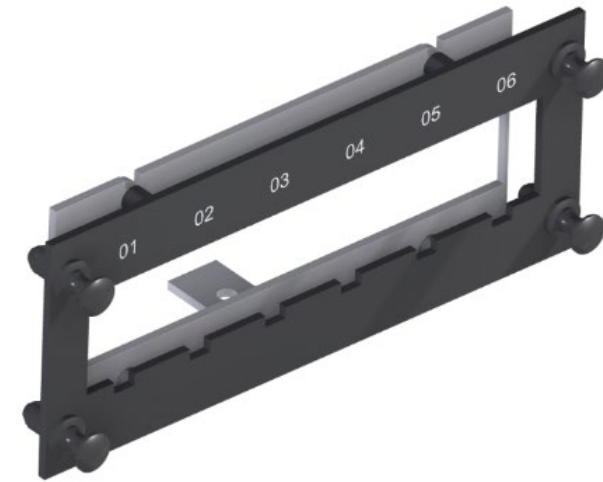

For 19" panel accessories see our product information 19" panel accessories:



Labeling fields

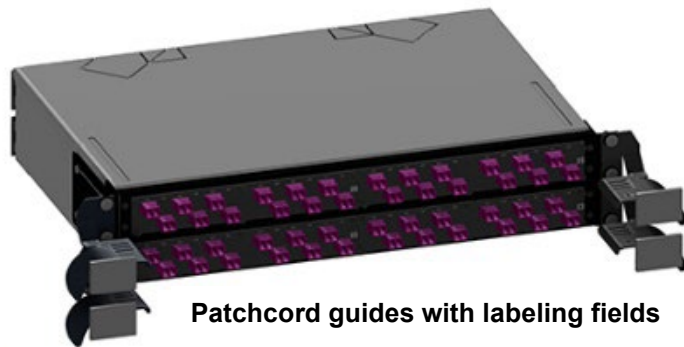

Patchcord guides with labeling fields

For other panel back planes see our product information SMAP-G2 SD:



Patchcord manager

- height units saving (0 HU) mountable in front of 19" panels
- with foldaway front cover
- with optional labelling and port address fields



About Rosenberger OSI:

Since 1991, Rosenberger Optical Solutions & Infrastructure (Rosenberger OSI) has been a recognized expert for fiber-based connectivity, cabling solutions and infrastructure services in the areas of data centers, local area networks, mobile networks and industrial applications. As an integrated solution provider, we have high expertise in the development and operational excellence in the production of system solutions for communication networks. Our comprehensive services enable the secure and efficient operation of digital infrastructures. This combination, combined with our strong customer focus, makes us unique and a strong partner in the global market.

Rosenberger OSI has been part of the globally operating Rosenberger Group since 1998. The Rosenberger Group is a leading global provider of high-frequency, high-voltage and fiber optic connectivity solutions with headquarters in Germany. For further information, please visit:

www.rosenberger.com/osi

Rosenberger

Rosenberger-OSI GmbH & Co. OHG

Optical Solutions & Infrastructure | Endorferstr. 6 | 86167 Augsburg | Telefon: +49 821 24924-0
info-osi@rosenberger.com | www.rosenberger.com/osi

Rosenberger® is a registered trademark of Rosenberger Hochfrequenztechnik GmbH & Co. KG. All rights reserved. © Rosenberger 2017

For technical reasons, we reserve us the right to make any deviations from the illustrations in the product information.
Transfer to third party only by authority of Rosenberger-OSI GmbH & Co. OHG- All rights reserve.

Creation date: 2019-09-12

Valid since: 2022-04-08

Revision: 007