

PRODUCTPROFILE

Catalogue number: 170A3220

Partnumber: 758320

SMAP-G2 SD Part-Front-Plate 1HU-1/4
with 12 LC-Duplex (6xLCQ) SM-APC green
adapters
RAL9005 black
incl. numbering field

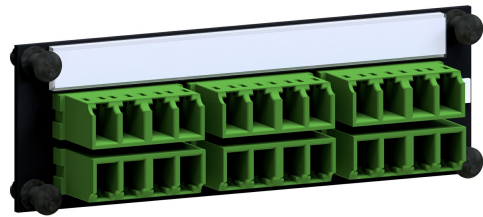

Related documents:

DS_LC_QUAD_KUPPLUNG_K04_OE
PRECONNECT_SMAP-G2-SD_OE

LC-Q Kupplung
Produktinformation

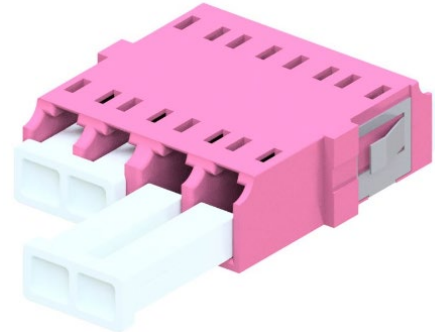
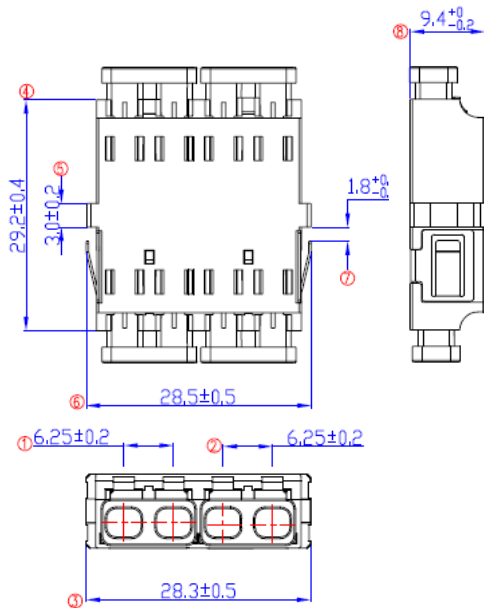

All dimensions are in [mm]; tolerances acc. ISO 2768 m-H

Properties and applications

- LC adapter connect LC-Simplex, LC-Duplex and LC-COMPACT connectors
- senior / senior = at both sides maximum long guidance of the LC connectors within the adapter
- One-piece break-proof adapter body
- Screwless mounting by mounting clip
- Translucence duplex protection cap, permeable for the light of laser pointers (visual fault locators)

Standards

IEC/EN 61754-20, TIA/EIA 604-10, REACH and RoHS compliant

Material

- C-Sleeve: Zirconia ceramic
- Adapter body: PEI, flammability UL94 V-0
- Mounting clip: Stainless spring steel
- Duplex protection cap: PVC, flammability UL94 V-0

Optical data

Insertion loss Change over mating cycles: Max. 0.2 dB

Mechanical data

Mating cycles: Min. 500

Thermal properties

- Operation temperature range: -40°C to +85°C
- Storage temperature range: -40°C to +85°C

Colors

aqua for OM3 / violet for OM4 / lime green for OM5 / blue for SM-PC 0° / green for SM-APC 8°

While the information has been carefully compiled to the best of our knowledge, nothing is intended as representation or warranty on our part and no statement herein shall be construed as recommendation to infringe existing patents. In the effort to improve our products, we reserve the right to make changes judged to be necessary.

Draft	Date	Approved	Date	Rev.	Engineering change number	Name	Date
H. Jungbäck	2021-02-09	R. Mees	2021-02-09	002	---	---	---

PreCONNECT® SMAP-G2 Smart Panel Generation 2 Standard Density (SD) 19" panel system

PRODUCT INFORMATION



Rosenberger OSI offers with PreCONNECT® SMAP-G2 SD a highly modular and plastic-reduced 19" Smart Panel SMAP panel system for data center data cabling. SMAP-G2 SD is available as distribution panel to accommodate all kinds of factory assembled cables and as splice panel.

A service-friendly assembly of the PFPs, MTP® module cassettes, trunk and splice modules is possible without tools by quick fasteners. Also the proven PreCONNECT® square-interface enables a toolless fixing of the trunks cables.

Depending on the application and configuration of the PreCONNECT® SMAP-G2 SD panels, a multitude of easily exchangeable back planes are available for cable interception. The PreCONNECT® SMAP-G2 SD panel is depth-adjustable by 19" mounting brackets and can therefore be individually adapted to different rack conditions.

Properties:

MEGA HIGH DENSITY (MHD) with MDC

- LC-Duplex and MTP®: 48 ports per HU at the 1, 2 and 3 HU panels, 57.6 per HU (total 288) at 5 HU
- **MDC: 128 ports per HU at the 1, 2 and 3 HU panels, 153.6 per HU (total 768) at 5 HU**
- Consisting of 1 HU and 2 HU empty panels with horizontal orientation of the part front plates and 3 HU and 5 HU with vertical orientation
- The empty panels are to be equipped with 1 HU 1/4 and 1/2 part front plates PFPs, MTP® module cassettes, trunk and splice modules
- The PFPs and cassettes are toolless inserted from the front side and fixed with quick fasteners
- The PFPs and cassettes can be pulled out to the front for maintenance
- Through its adjustable 19" mounting brackets the panel can be depth variable mounted
- Trunk cables can be routed into the panels through their back planes and either side
- At panels with trunk routing through their back planes, which are not fully equipped during their first installation, trunk cables can be retrofitted afterwards and removed for maintenance

Applications:

- Panel system for data center data cabling
- For all IT applications like Ethernet and Fibre Channel
- Appropriate for Spine-Leaf architectures, by default 12, optional up to 16 trunks coming from Leaf Switches can be accommodated per HU within SMAP-G2 distribution panels next to the Spine-Switch

Your benefits at a glance:

- High modularity to configure individual cabling structures
- Fast and easy handling during first installation, retrofit and maintenance, one-man installation possible
- Low complexity, focused on the functional needs
- Simple and low-cost migration to other applications, e.g. from duplex technology to MTP® based Parallel Optics
- Fiber and copper data cabling can be installed together within one panel
- Low fire load through minimized use of plastic

PreCONNECT® SMAP-G2 SD 19" panel system:

PreCONNECT® SMAP-G2 is the generation 2 of our since years proved and tested, highly-modular and plastics reduced 19" Smart Panel SMAP systems for data center data cabling. SMAP-G2 SD is available as distribution panel to accommodate all kinds of factory assembled cables and as splice panel.

Port density: 48 LC-Duplex or MTP® ports per height unit HU at the 1, 2 and 3 HU panels and 57.6 per HU (total 288) at the 5 HU panel

PreCONNECT® SMAP-G2 SD consists of 1 HU and 2 HU empty panels with horizontal orientation of the part front plates and 3 HU and 5 HU with vertical orientation.

The empty panels are to be equipped with 1 HU 1/4 and 1/2 part front plates PFPs, MTP® module cassettes, trunk and splice modules (1). The PFPs, cassettes and modules are toolless inserted from the front side and fixed with quick fasteners. By this design they can be pulled out to the front for maintenance.

1 HU 1/4 part front plates fitting into all SMAP-G2 SD empty panels, the 1 HU 1/2 part front plates fitting into the 1 and 2 HU with horizontal orientation and into the 5 HU with vertical orientation. 1 HU 1/2 PFPs does not fit into the 3 HU with vertical orientation.

The modular panel back planes (2) offering highest flexibility to configure cable entries application specific easy and cost-saving. See the configurations of the back planes in the descriptions of the empty panels.

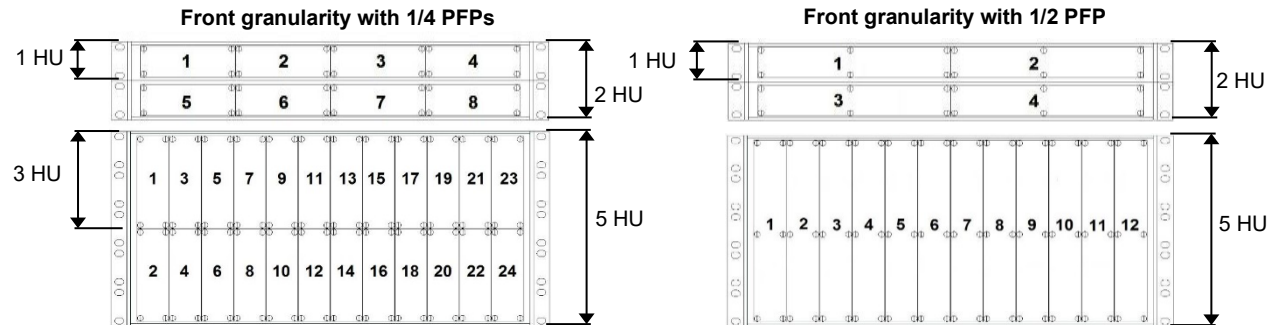
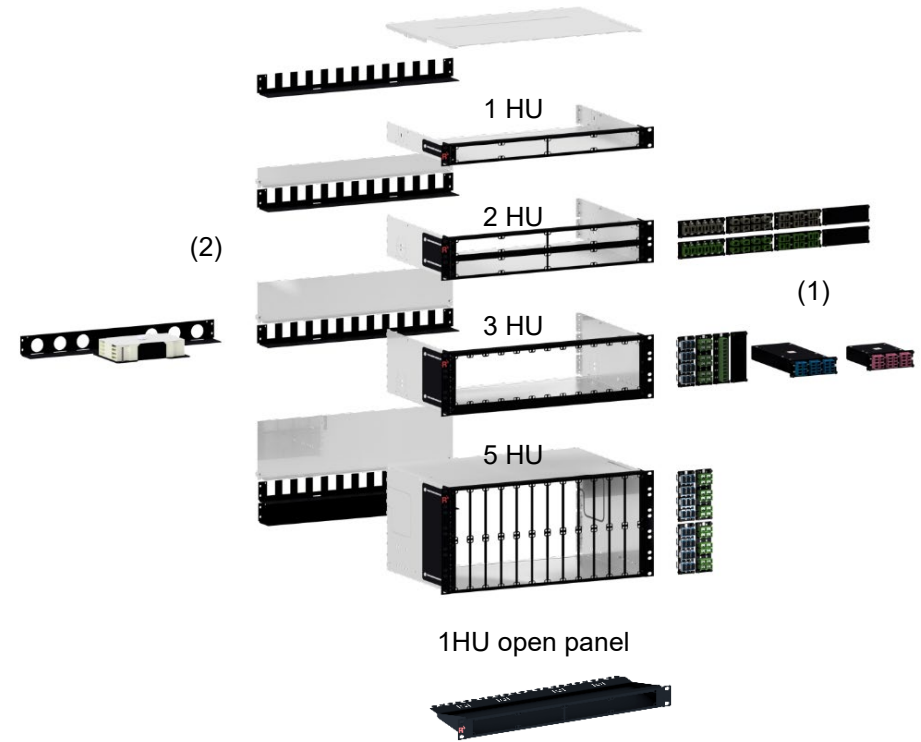

SMAP-G2 SD distribution panel for PreCONNECT® trunks:

With our since 1991 proved and tested PreCONNECT® square-interface within the panel back planes, the PreCONNECT® trunk cable dividers can be toolless hooked into panels back planes for tensile and torsion resistant fixing of the trunks.

Material and color:

- Panel body: aluminum silver
- 19" mounting brackets and front: steel powder coated RAL9005 black

Weight:

One of the lowest weight panels of its kind: 1HU empty distribution panel 1.6 kg

Dimensions:

- Width: 19"
- Height: 1, 2, 3 and 5 HU
- Depth: 200 mm and 300 mm. Through the captive screws of their back plane blind covers, the 2, 3 and 5 HU panels are 212 mm and 312 mm deep. We recommend 300 mm as shown here, because the space to accommodate trunk cable dividers and connector legs is enough, but uncomfortable narrow within 200 mm deep panels.

Part numbers:

SMAP-G2 SD 19" empty distribution panels, RAL9005 black, back plane with 12 PreCONNECT® square interfaces, as shown here. PreCONNECT® square interfaces dustproof covered with tool less removable blanks, here not shown.

1 HU, depth 300 mm	171A0001
1 HU, depth 200 mm	171A0020
1 HU open panel, depth 185 mm	171A0030
2 HU, depth 300 mm	172A0001
3 HU, depth 300 mm	173A0001
5 HU, depth 300 mm	175A0001

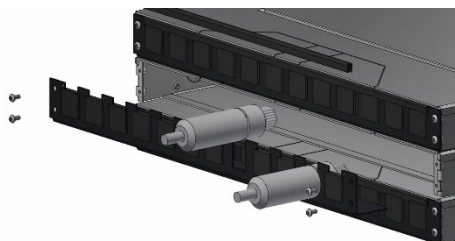

The back plane of the 1 HU panel can be removed for retrofit and maintenance of trunk cables.

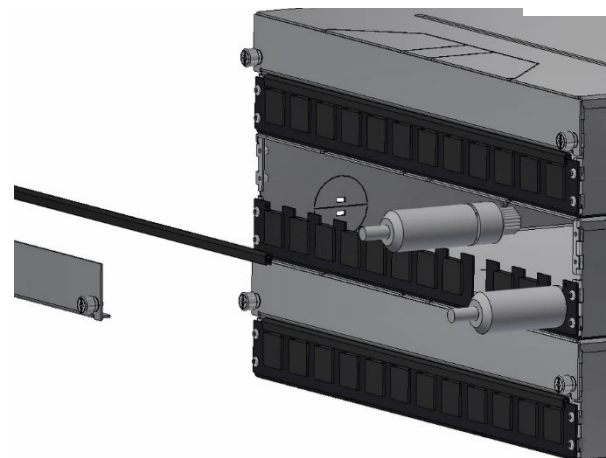

Back plane blind covers at 2, 3 and 5 HU panels can be removed by their captive screws for comfortable trunk cable retrofit and maintenance.

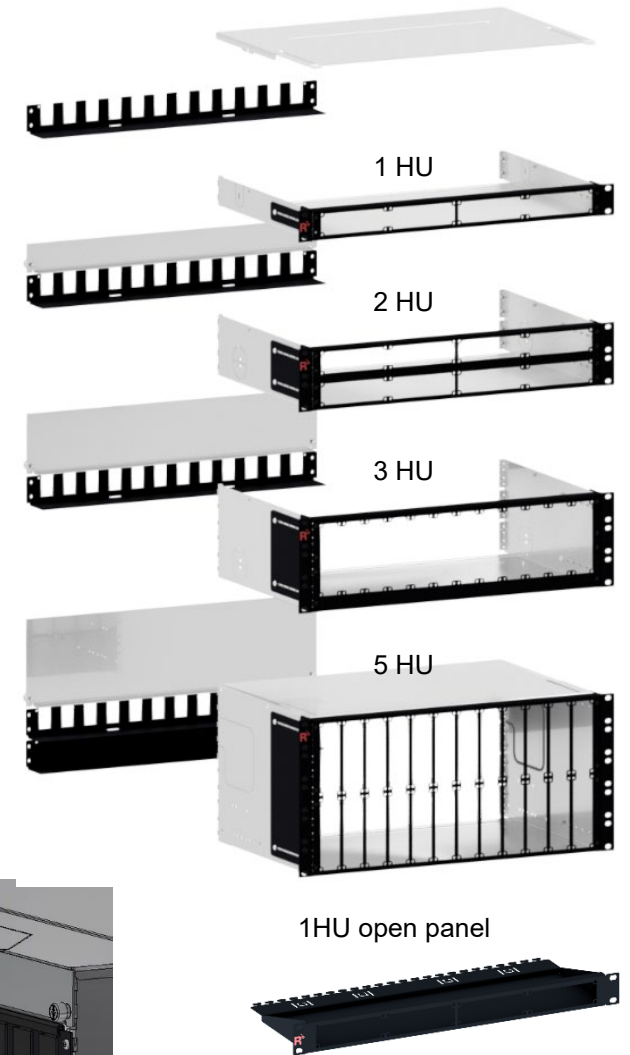

PreCONNECT® SMAP-G2 SD 19" panel system:

Through their adjustable 19" mounting brackets, the panels can be stepless mounted to protrude to the front over the 19" level (Position A), or to stay recessed behind it (Position B).

Position	panel depth	X [mm]	Y [mm]
A: protrusion to the front, over the 19" level	200 mm	160	40
	300 mm	225	75
B: recessed behind the 19" level	200 mm	155	45
	300 mm	255	45

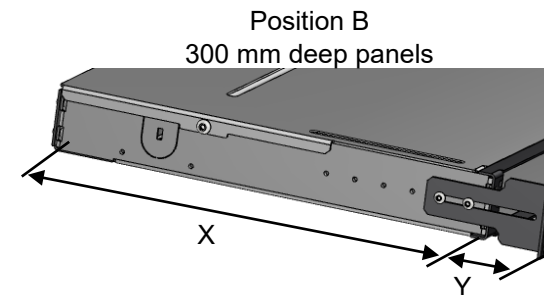
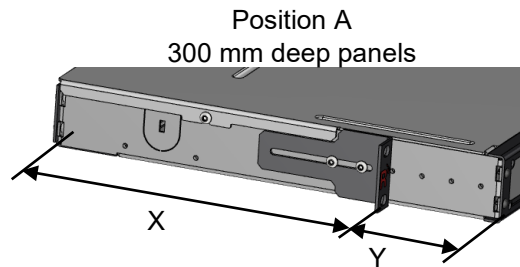
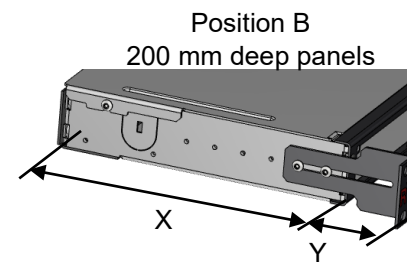
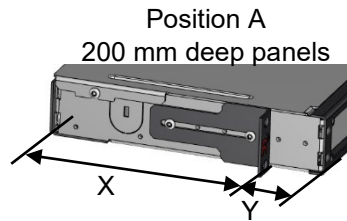

Through the captive screws of their back plane blind covers, the 2, 3 and 5 HU panels are 212 mm and 312 mm deep. This must be considered at position A in particular, because the panels in these cases need X + 12 mm more depth space.

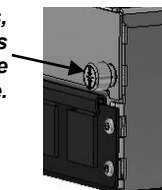

PreCONNECT® SMAP-G2 SD 19" panel system:

Part numbers:

SMAP-G2 SD 19" empty distribution panels, RAL9005 black, with diverse back planes:

1 HU, depth 300 mm, with modular back plane 2x3 170A1520	171A0004
1 HU, depth 300 mm, with modular back plane 4x1 170A1521	171A0011
See these back plane types separate behind in this product information.	

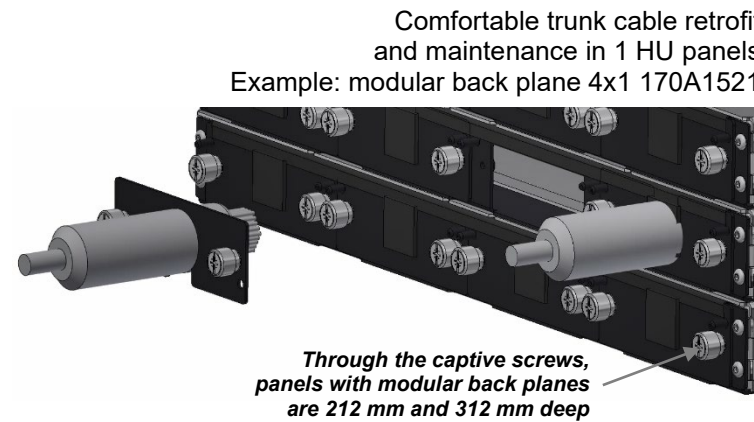

PreCONNECT® SMAP-G2 SD 19" panel system:

Part numbers:

SMAP-G2 SD 19" empty distribution panels, RAL9005 black, with diverse back planes:

1 HU, depth 300 mm, with blind back plane 170A1501 and two trunk cable divider holders 170A1523 to route one trunk cable each through either side of the panel	171A0012
1 HU, depth 200 mm, with blind back plane 170A1501 and two trunk cable divider holders 170A1523 to route one trunk cable each through either side of the panel	171A0015

At 1, 2 and 3 HU panels, one trunk cable each can be routed into the panel at either side through to quarry out perforations (1) and can be fixed within internal trunk cable divider holders (2), which can be mounted within the panels.

This trunk side entry can't be applied at panels equipped with MTP® module cassettes.

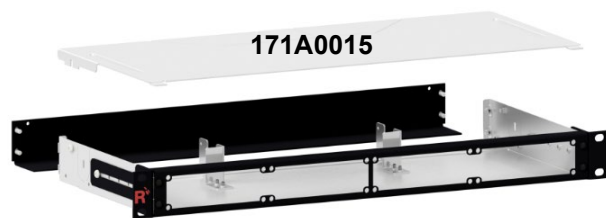

(2) internal trunk cable divider holder for 1, 2 and 3 HU, can be ordered as accessorie part number: 170A1523

Mounted within 1 HU 200mm



(1) to quarry out perforation

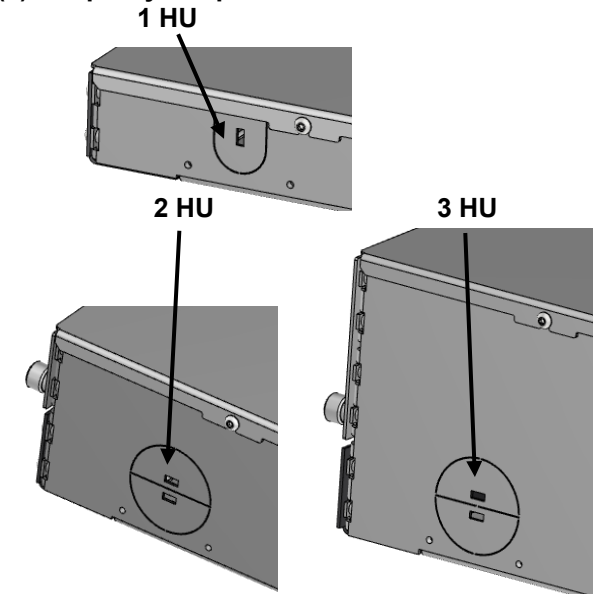

PreCONNECT® SMAP-G2 SD 19" panel system:

To rout patchcords through the side walls into the 1, 2 and 3 HU panels, the universal cable strain relief (1) is available.

At the 5 HU panel, trunk cables can be routed into the panel at either side through to quarry out perforations (2) and can be fixed within external trunk cable divider holders (3), which can be mounted at the panel's side walls.

(1) universal cable strain relief for 1, 2 and 3 HU
part number: 170A1526

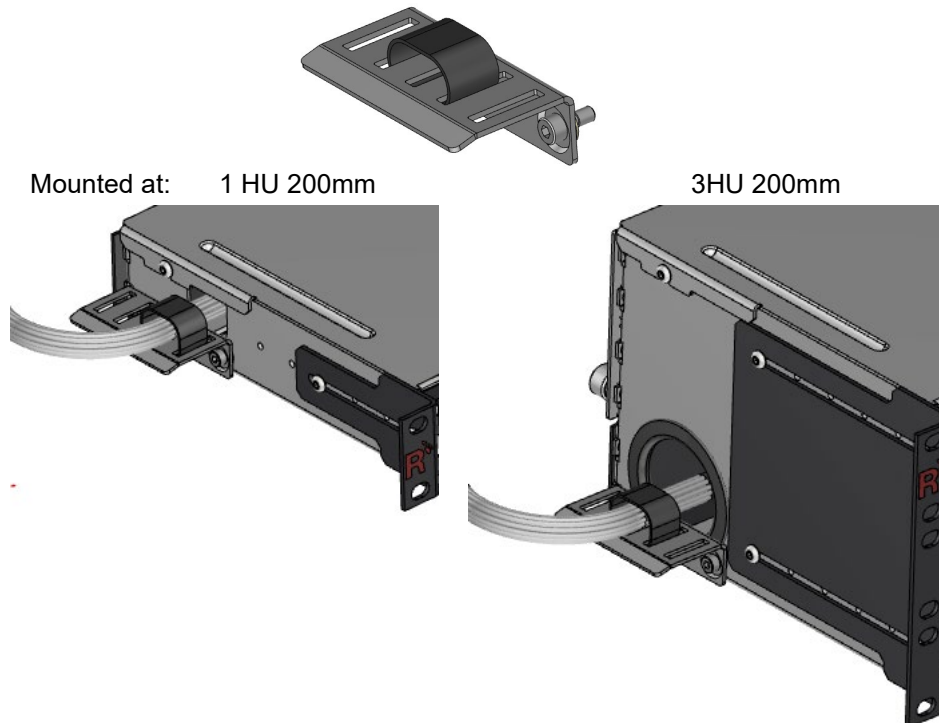

(2) to quarry out perforation 5 HU

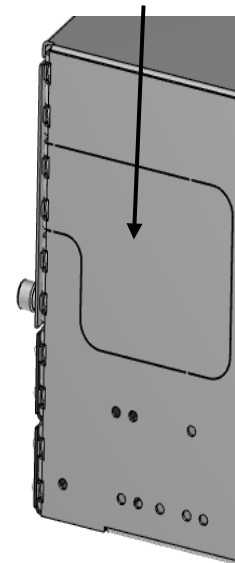

(3) trunk cable divider holder for 5 HU
part number: 170A1508

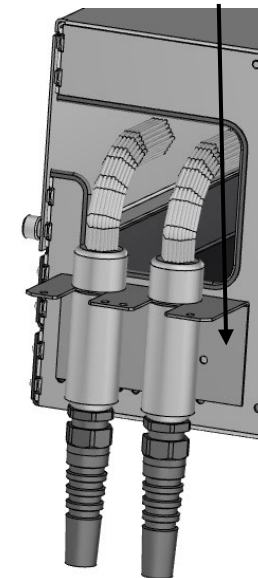

PreCONNECT® SMAP-G2 SD 19" panel system:

Part numbers:

SMAP-G2 SD 19" empty distribution panels, RAL9005 black, with diverse back planes:

1 HU, depth 300 mm, with back plane 170A1507	171A0005
1 HU, depth 300 mm, with back plane 170A1512	171A0013
1 HU, depth 300 mm, with back plane 170A1515	171A0014
1 HU, depth 300 mm, with back plane 170A1516	171A0009
1 HU, depth 300 mm, with back plane 170A1518	171A0003
See these back plane types separate behind in this product information.	

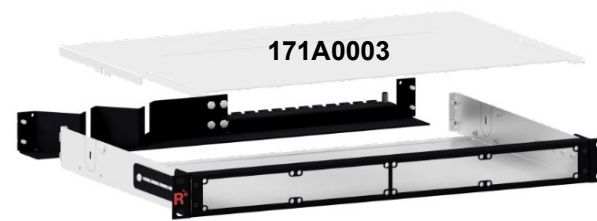
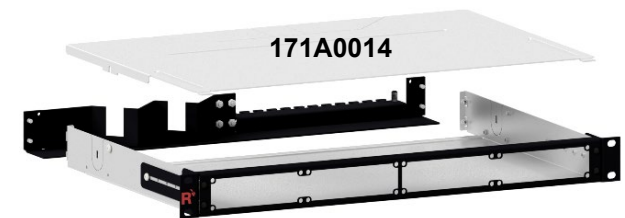
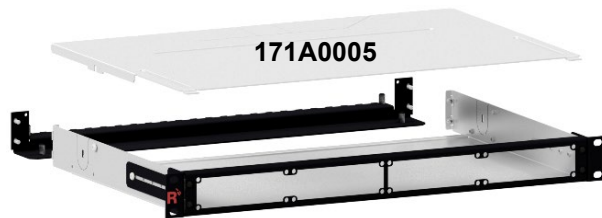

SMAP-G2 SD 1 HU 1/4 part front plates with matrix numbering:

All SMAP-G2 SD empty panels can be equipped with 1 HU 1/4 part front plates PFPs. The PFPs are toolless inserted from the front side and fixed with quick fasteners. By this design they can be pulled out to the front for maintenance.

The numbering of the part front plates PFP is a modular numerical matrix. The Ports have a fixed 1 to n labeling (n = number of channels per PFP), e.g. 1 to 6 as shown here at the 1/4 PFP with 6 LC-Duplex.

The PFPs can be numbered with their positions they have within the panels with the exchangeable numbering clips the panels are shipped with. For the PFP's positions within the panels see the matrix diagram below. E.g.: Port 3 – 4 means, PFP number 3 and therein the port number 4.

Material and color: steel powder coated RAL9005 black

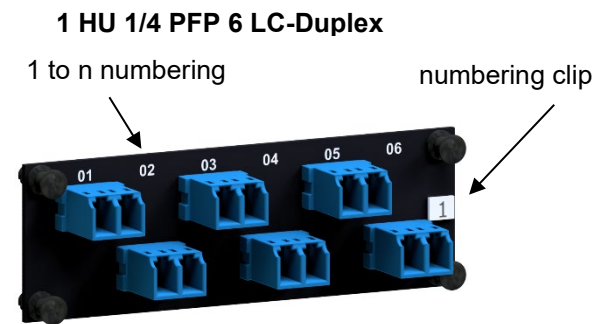
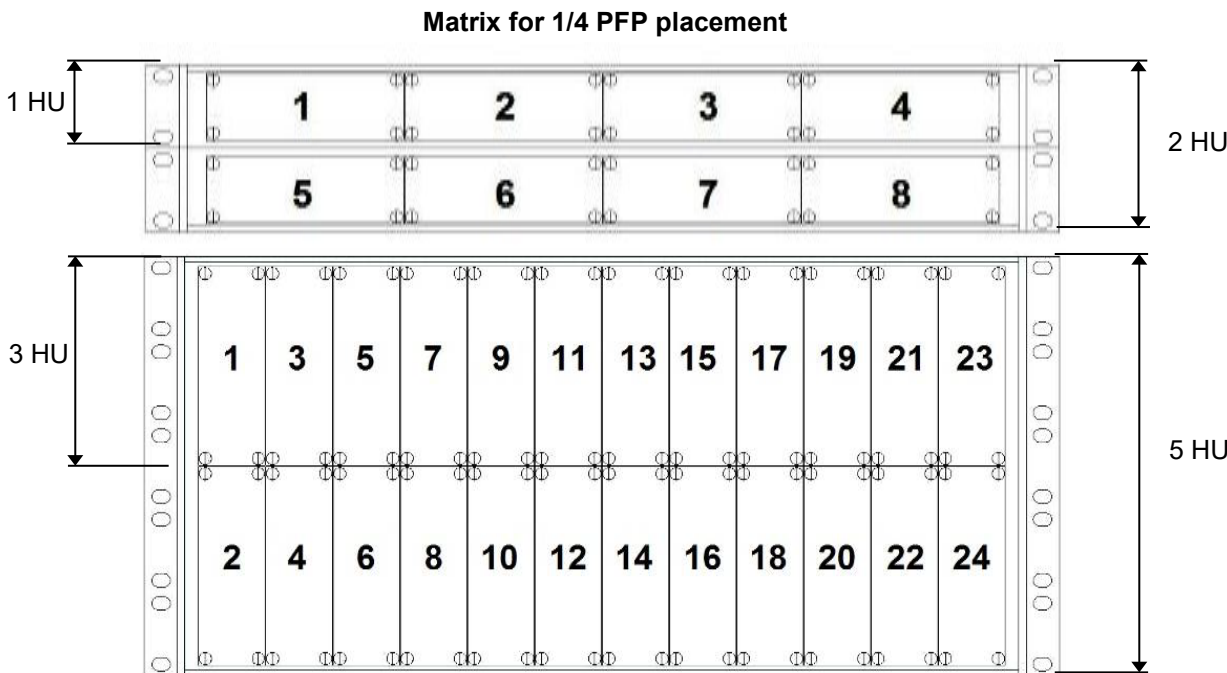

SMAP-G2 SD 1 HU 1/4 part front plates with matrix numbering:

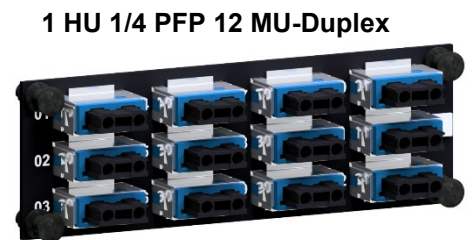
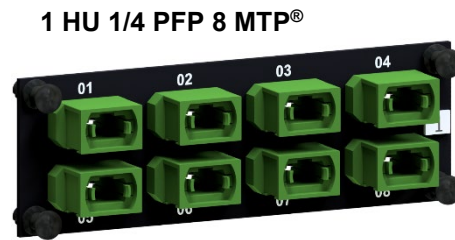
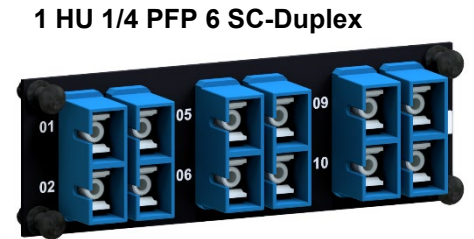
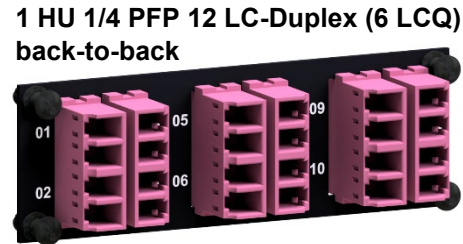
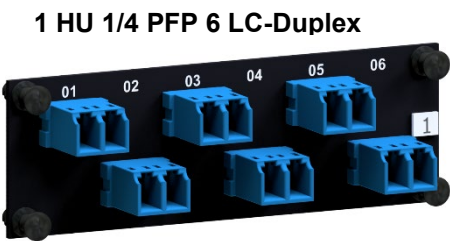

Part numbers RAL9005 black				
Number of adapter type/fibers	for fiber type			
	SM PC 0° blue	SM APC 8° green	OM4 violet	MM grey
Blind PFP	170A0001			
6 LC-Duplex / 12F	170A0110	170A0120	170A0130OM4	---
12 LC-Duplex (6 LCQ) / 24F back-to-back	170A0210	170A0220	170A0230OM4	---
12 LC-Duplex (6 LCQ) / 24F conventional	170A0211	170A0275	170A0237OM4	---
6 MTP®	---	type A "opposed key" 170A0620	magenta type A "opposed key" 170A0630OM4	type B "aligned key" 170A0630TB
8 MTP®	---	type A "opposed key" 170A0140	---	type B "aligned key" 170A0141TB
12 MTP®	---	type A "opposed key" 170A0623	---	type B "aligned key" 170A0636TB
12 MU-Duplex-H / 24F	170A0310	170A0320	170A0330OM4	---
6 SC-Duplex / 12F	170A0410	170A0420	170A0430OM4	---
6 E-2000®-Compact / 12F	170A0510	170A0520	---	---

With other adapter types on request.

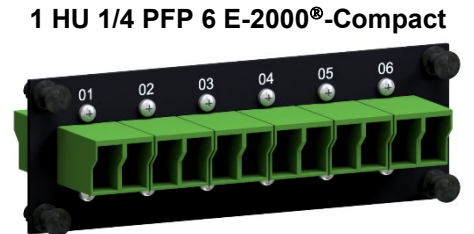

SMAP-G2 SD 1 HU 1/4 part front plates with matrix numbering:

Part numbers RAL9005 black			
Number of adapter type/fibers	for fiber type		
	SM PC 0° blue	SM APC 8° green	OM4 violet
8 MDC4 / 64F numbering readable at horizontal mounting	170A0005	on request	170A0006OM4
8 MDC4 / 64F numbering readable at vertical mounting	170A0009	on request	170A0010OM4

Find part numbers for panels factory assembled with part front plates in our product information SMAP-G2 SD.

MEGA HIGH DENSITY (MHD) with MDC

**1 HU 1/4 PFP 8 MDC4
numbering readable at horizontal mounting**

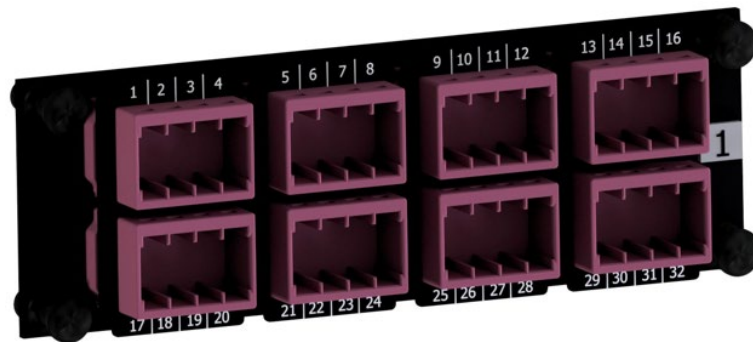

**1 HU 1/4 PFP 8 MDC4
numbering readable at vertical mounting**



SMAP-G2 SD 1 HU 1/2 part front plates with matrix numbering:

SMAP-G2 SD 1 HU, 2 HU and 5 HU can be equipped with 1 HU 1/4 part front plates PFPs, 3 HU can't. The PFPs are toolless inserted from the front side and fixed with quick fasteners. By this design they can be pulled out to the front for maintenance.

The numbering of the part front plates PFP is a modular numerical matrix. The Ports have a fixed 1 to n labeling (n = number of channels per PFP), e.g. 1 to 12 as shown here at the 1/2 PFP with 12 LC-Duplex.

The PFPs can be numbered with their positions they have within the panels with the exchangeable numbering clips the panels are shipped with. For the PFP's positions within the panels see the matrix diagram below. E.g.: Port 3 – 4 means, PFP number 3 and therein the port number 4.

Material and color: steel powder coated RAL9005 black



Matrix for 1/2 PFP placement

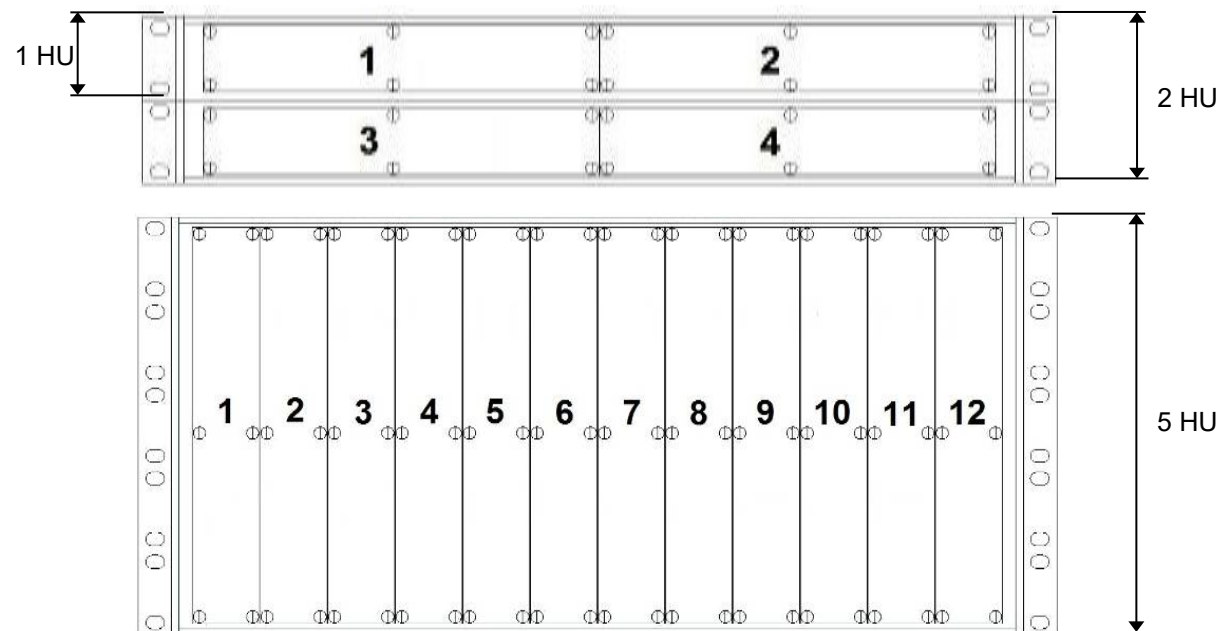

1HU 1/2 PFP 12 LC-Duplex

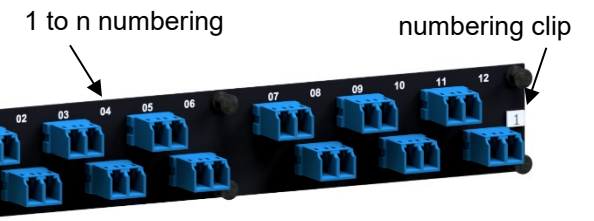

SMAP-G2 SD 1 HU 1/2 part front plates with matrix numbering:

1 HU 1/2 PFP 12 LC-Duplex



1 HU 1/2 PFP 24 LC-Duplex (12 LCQ)



1 HU 1/2 PFP 12 MTP®



1 HU 1/2 PFP 12 SC-Duplex



1 HU 1/2 PFP 24 MU-Duplex-Horizontal



1 HU 1/2 PFP 24 MTP®



1 HU 1/2 PFP 12 E-2000®-Compact

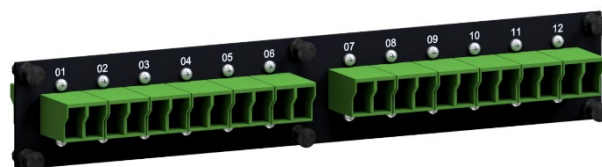

1 HU 1/2 Blind PFP



Part numbers RAL9005 black				
Number of adapter type/fibers	for fiber type			
	SM PC 0° blue	SM APC 8° green	OM4 violet	MM grey
Blind PFP	170A0002			
12 LC-Duplex / 24F	170A0150	170A0160	170A0170OM4	---
24 LC-Duplex (12 LCQ) / 48F	170A0250	170A0260	170A0270OM4	---
12 MTP®	---	type A "opposed key" 170A0660	magenta type A "opposed key" 170A0670OM4	type B "aligned key" 170A0670TB
24 MTP®	---	type A "opposed key" 170A0664	---	type B "aligned key" 170A0674TB
24 MU-Duplex-H / 48F	170A0350	170A0360	170A0370OM4	---
12 SC-Duplex / 24F	170A0450	170A0460	170A0470OM4	---
12 E-2000®-Compact / 24F	170A0550	170A0560	---	---

With other adapter types on request.

SMAP-G2 SD panels, 300mm deep, factory assembled with 1 HU part front plates with matrix numbering and back plane with 12 PreCONNECT® square interfaces:

Part numbers RAL9005 black				
HU	Number of PFP and type	Number of LC-Duplex ports	SM PC 0° blue	OM4 violet
1	4 x 1 HU 1/4 6 LCQ	48	171A5001	171A5000OM4
1	2 x 1 HU 1/2 12 LCQ	48	171A5003	171A5002OM4
2	8 x 1 HU 1/4 6 LCQ	96	171A5005	171A5004OM4
2	4 x 1 HU 1/2 12 LCQ	96	172A5007	172A5006OM4
HU	Number of PFP and type	Number of MTP® ports	SM APC 8° green type A "opposed key"	OM4 grey type B "aligned key"
1	4 x 1 HU 1/4 6 MTP®	24	171A5009	171A5008OM4
1	4 x 1 HU 1/4 8 MTP®	32	171A5013	171A5012OM4
1	4 x 1 HU 1/4 12 MTP®	48	171A5011	171A5010TB
2	8 x 1 HU 1/4 6 MTP®	48	171A5015	171A5014OM4
2	8 x 1 HU 1/4 8 MTP®	64	171A5019	171A5018OM4
2	8 x 1 HU 1/4 12 MTP®	96	172A5017	172A5016TB

Other HU and configuration on request.



SMAP-G2 SD 1 HU 1/4 part front plates with labelling field:

1 HU 1/4 PFP 6 LC-Duplex

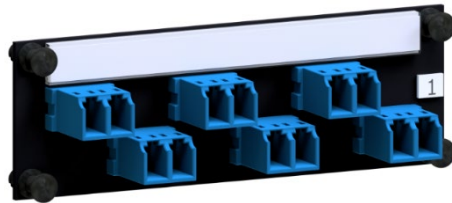

1 HU 1/4 PFP 12 LC-Duplex (6 LCQ)

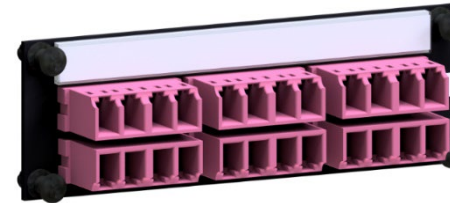

1 HU 1/4 PFP 6 MTP®



1 HU 1/4 PFP 6 E-2000®-Compact

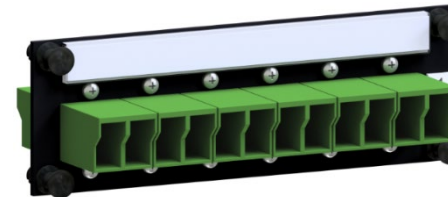

Part numbers RAL9005 black			
Number of adapter type/fibers	for fiber type		
	SM PC 0° blue	SM APC 8° green	OM4 violet
6 LC-Duplex / 12F	170A3110	170A3120	170A3130OM4
12 LC-Duplex (6 LCQ) / 24F	170A3210	170A3220	170A3230OM4
6 MTP®	---	type A "opposed key" 170A3620	magenta type A "opposed key" 170A3630OM4
6 E-2000®-Compact / 12F	170A3510	170A3520	---
With other adapter types on request.			

SMAP-G2 SD 24 fibers trunk module:

Properties:

- To accommodate two 12 fiber or one 24 fiber PreCONNECT® STANDARD trunks with standard stepped „A leg lengths“, as described in the product information PreCONNECT® STANDARD
- Height: 1 HU
- Width: 1/4
- Depth: 201 mm, fits in 300 mm deep panels only
- Toolless placement of the trunk module into the panel from the front side, fixing with quick fasteners
- Material and colour:
 - Cassette body: aluminum powder coated RAL9005 black
 - Front: steel powder coated RAL9005 black

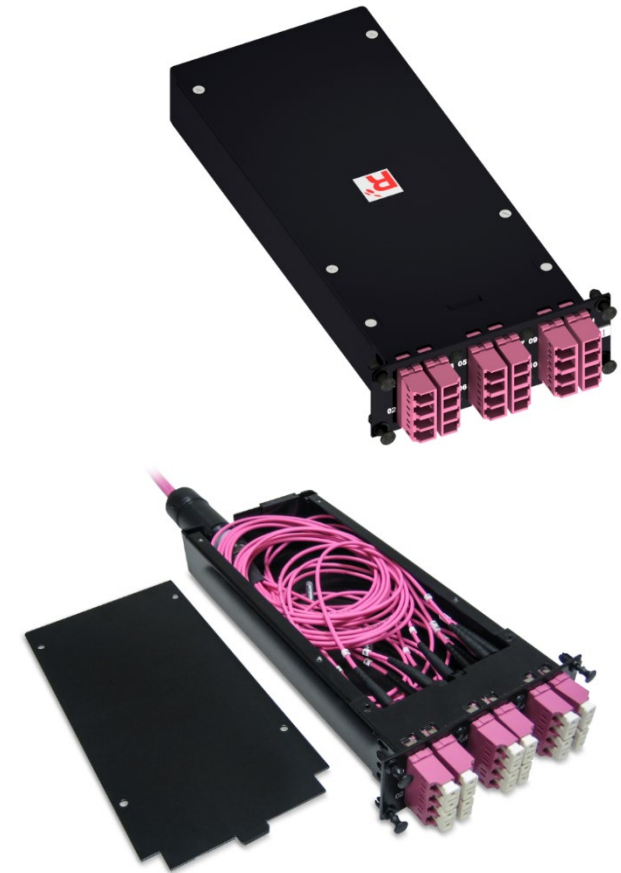

Part numbers RAL9005 black			
Number of LC-Duplex ports at front side	OM4	SM LC-PC 0°	SM LC-APC 8°
12	170A2052OM4	170A2050	170A2051

Fixing of PreCONNECT® STANDARD trunks at panel back plane using PreCONNECT® universal cable fixture. For cable diameters 6 to 18 mm.

Part number set incl. two cable ties: 111A0650

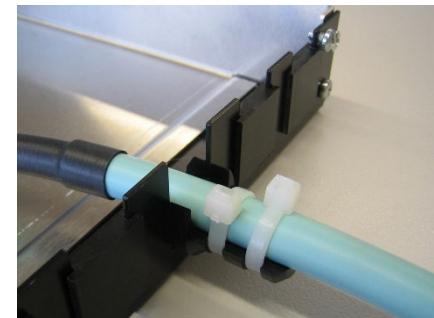

SMAP-G2 SD 24 fiber MTP®-LC module cassettes fitting for PreCONNECT® OCTO trunks:

Properties:

- For Port-Breakout of PreCONNECT® OCTO trunks with MTP® connectors, as described in the product information PreCONNECT® OCTO
- Height: 1 HU
- Width: 1/4
- Depth: 115 mm
- Polarity: Rx to Tx
- 3x MTP® female port 4+4F OCTO at the rear side:
 - OM4: Elite quality MTP® adapter type B „aligned key” grey
 - SM: Standard quality, MTP® adapter type A „opposed key” green
- 12 LC-Duplex ports at the front side
- Toolless placement of the module cassettes into the panel from the front side, fixing with quick fasteners
- Material and colour:
 - Cassette body: aluminum powder coated RAL9005 black
 - Front: steel powder coated RAL9005 black

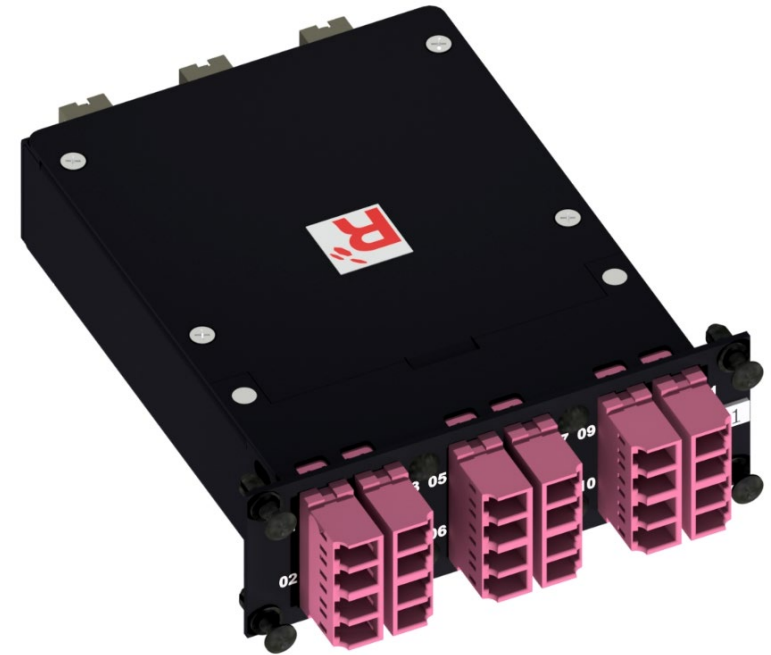

Part numbers RAL9005 black				
Number of 4+4F OCTO MTP® female ports at rear side	Number of LC-Duplex ports at front side	OM4	SM LC-PC 0°	SM LC-APC 8°
3	3 OCTO groups of 4 = 12	170A2026OM4	170A2027	on request

SMAP-G2 SD panels, 300mm deep, factory assembled with 1 HU 1/4 MTP®-LC module cassettes 3 x OCTO and back plane with 12 PreCONNECT® square interfaces:

Part numbers RAL9005 black				
HU	Number of cassettes and type	Number of LC-Duplex ports	OM4	SM LC-PC 0°
1	4 x 1 HU 1/4 6 LCQ	48	171A2000OM4	171A2001
2	8 x 1 HU 1/4 6 LCQ	96	172A2002OM4	172A2003
Other HU and configuration on request.				

SMAP-G2 SD 24 fiber MTP®-LC module cassettes fitting for PreCONNECT® DUODECIM trunks:

Properties:

- For Port-Breakout of PreCONNECT® DUODECIM trunks with MTP® connectors, as described in the product information PreCONNECT® DUODECIM
- Height: 1 HU
- Width: 1/4
- Depth: 115 mm
- Polarity: Rx to Tx
- 2x MTP® female port 12F DUODECIM at the rear side:
 - OM4: Elite quality MTP® adapter type B „aligned key” grey
 - SM: Standard quality, MTP® adapter type A „opposed key” green
- 12 LC-Duplex ports at the front side
- Toolless placement of the module cassettes into the panel from the front side, fixing with quick fasteners
- Material and colour:
 - Cassette body: aluminum powder coated RAL9005 black
 - Front: steel powder coated RAL9005 black

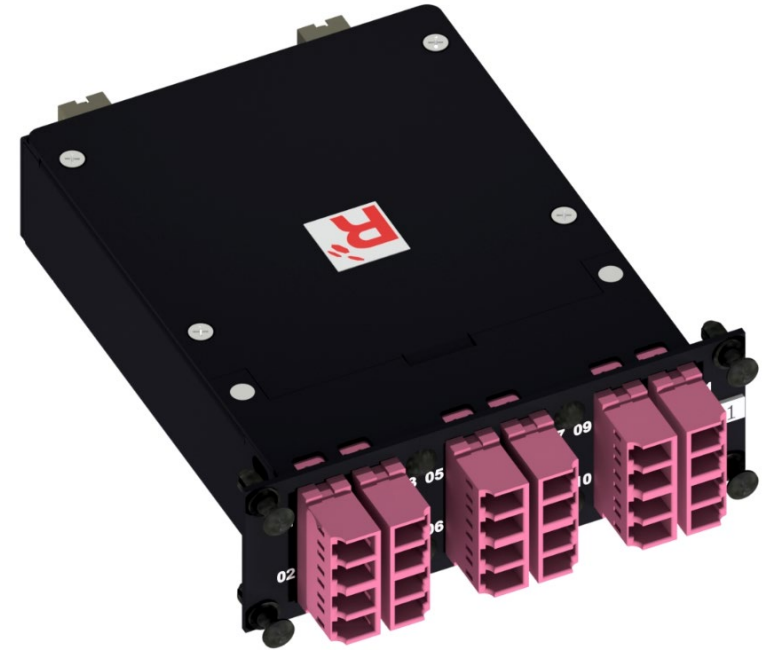

Part numbers RAL9005 black				
Number of 12F DUODECIM MTP® female ports at rear side	Number of LC-Duplex ports at front side	OM4	SM LC-PC 0°	SM LC-APC 8°
2	2 DUODECIM groups of 6 = 12	170A2025OM4	170A2004	on request

SMAP-G2 SD panels, 300mm deep, factory assembled with 1 HU 1/4 MTP®-LC module cassettes 2 x DUODECIM and back plane with 12 PreCONNECT® square interfaces:

Part numbers RAL9005 black				
HU	Number of cassettes and type	Number of LC-Duplex ports	OM4	SM LC-PC 0°
1	4 x 1 HU 1/4 6 LCQ	48	171A5200OM4	171A5201
2	8 x 1 HU 1/4 6 LCQ	96	172A5202OM4	172A5203

Other HU and configuration on request.

**SMAP-G2 SD PURE
19" Distribution Panels empty:**

Part numbers RAL9005 black, 300mm depth	
1 HU	171A0001P
2 HU	172A0001P
3 HU	173A0001P
5 HU	175A0001P

PreCONNECT® PURE LC-Duplex
adapter-interface
at Trunk connector legs

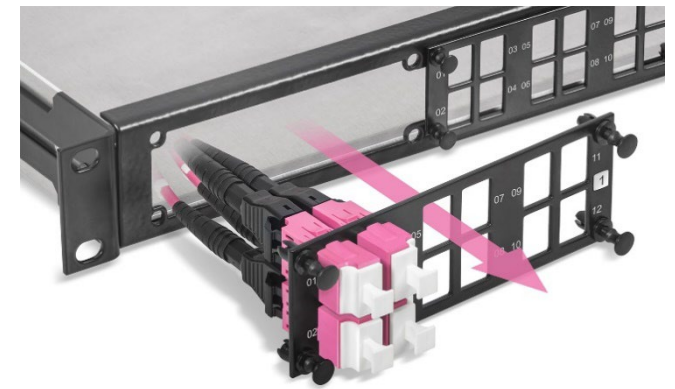

**Back planes with 12 PreCONNECT®
square interfaces**



SMAP-G2 PURE Part-Front-Plates PFP

1 HU 1/4 PFP for 12 LC-Duplex adapter-interfaces

1 HU 1/2 PFP for 24 LC-Duplex adapter-interfaces

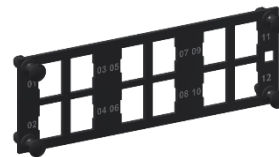

1 HU 1/4 Blind-PFP

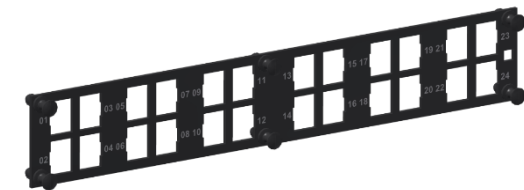

1 HU 1/2 Blind-PFP



SMAP-G2 PURE 1 HU 1/4 and 1/2 Part-Front-Plates part numbers RAL9005 black	
PFP type / number of adapter slots	SMAP-G2 PURE Part-Front-Plates without adapters
1/4 Blind-PFP	170A0001P
1/2 Blind-PFP	170A0002P
1/4 / 12 LC-Duplex	170A0130P
1/2 / 24 LC-Duplex	170A0170P

SMAP-G2 SD 6 Port RJ45 Keystone part front plate fitting for PreCONNECT® COPPER trunks with RJ45 Keystone Jacks:

Properties:

- To carry PreCONNECT® COPPER and COPPER ToR-G2 trunks assembled with RJ45 Keystone Jacks, as described in the product information PreCONNECT® COPPER and COPPER ToR-G2
- For 6 RJ45 Keystone Jacks
- Height: 1 HU
- Width: 1/4
- Toolless placement of the module cassettes into the panel from the front side, fixing with quick fasteners
- Inclusive 2m long grounding cable to connect the PFP, grounding cable is to be routed out of the panel through its back plane and attached at the grounding point of the rack
- Material and colour: steel powder coated RAL9005 black



Part numbers RAL9005 black: 170A4010

PreCONNECT® COPPER and COPPER ToR-G2 trunk

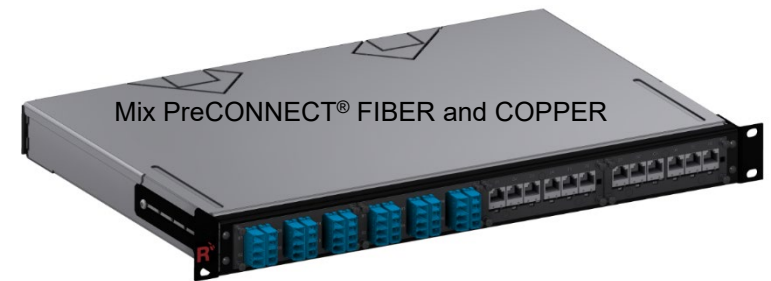

Fixing of PreCONNECT® COPPER trunks at panel back plane using PreCONNECT® universal cable fixture. For cable diameters 6 to 18 mm.

Part number set incl. two cable ties: 111A0650

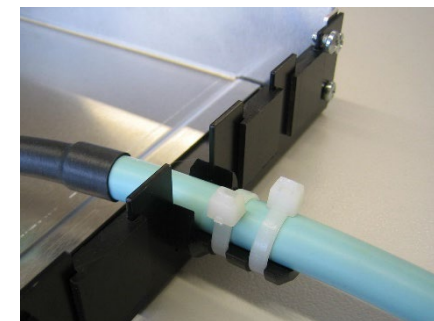

SMAP-G2 SD splice panel:

For splice cabling our SMAP-G2 SD 19" panel system is available as splice panel too.

SMAP-G2 SD 19" splice panel can be ordered empty or equipped with our gel-free/dry factory assembled splice cassettes (1) and the fitting splice protectors and splice holders.

We ask you while your request if you like to order cable glands as well. If you order all our offered options with the panel, it comes ready for splicing equipped. You don't need to strip single pigtails and eventually clean gel moistened fibers and you have all necessary accessories present.

The empty splice panels are by default equipped with the back plane for 6 PG21 cable glands per panel as shown here. 4 splice cassettes can be stacked per HU. See more back plane options in chapter accessories.

Dimensions:

- Width: 19"
- Height: 1 and 2 HU
- Depth: 300 mm

Material and colour:

- Panel body: aluminum silver
- 19" mounting brackets and front: steel powder coated RAL9005 black

Weight:

One of the lowest weight panels of its kind: 1 HU empty splice panel 1.8 kg

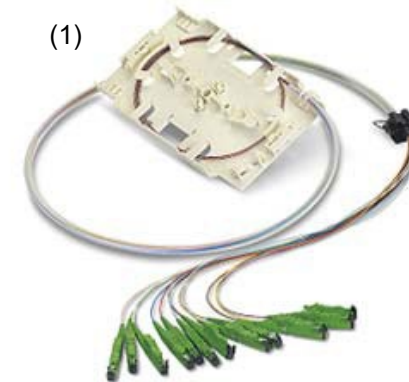
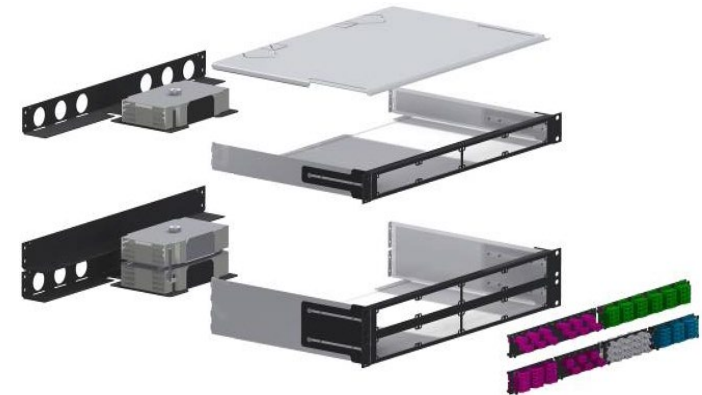

SMAP-G2 SD splice panel:

We ask you while your request if you like to order factory assembled splice cassettes, the fitting splice protectors and splice holders and cable glands as well. If you order all our offered options with the panel, it comes ready for splicing equipped. You don't need to strip single pigtailed and eventually clean gel moistened fibers and you have all necessary accessories present.

Part numbers SMAP-G2 SD 19" splice panel, RAL9005 black					
HU	Adapter type/number of channels (ports)/ number of fibers/number of PFP type	for fiber type			
		SM PC 0° blue	SM APC 8° green	OM3 aqua	OM4 violet
1	LC-Duplex / 12ch / 24F / 2x1/4	171A3111	171A3121	171A3131OM3	171A3131OM4
	LC-Duplex / 24ch / 48F / 4x1/4	171A3113	171A3123	171A3133OM3	171A3133OM4
	LC-Duplex / 12ch / 24F / 1x1/2	171A3150	171A3160	171A3170OM3	171A3170OM4
	LC-Duplex / 24ch / 48F / 2x1/2	171A3151	171A3161	171A3171OM3	171A3171OM4
	SC-Duplex / 12ch / 24F / 2x1/4	171A3411	171A3421	171A3431OM3	171A3431OM4
	SC-Duplex / 24ch / 48F / 4x1/4	171A3413	171A3423	171A3433OM3	171A3433OM4
	SC-Duplex / 12ch / 24F / 1x1/2	171A3450	171A3460	171A3470OM3	171A3470OM4
	SC-Duplex / 24ch / 48F / 2x1/2	171A3451	171A3461	171A3471OM3	171A3471OM4
	E-2000®-Compact / 12ch / 24F / 2x1/4	171A3511	171A3521	171A3531OM3	171A3531OM4
	E-2000®-Compact / 24ch / 48F / 4x1/4	171A3513	171A3523	171A3533OM3	171A3533OM4
	E-2000®-Compact / 12ch / 24F / 1x1/2	171A3550	171A3560	171A3570OM3	171A3570OM4
	E-2000®-Compact / 24ch / 48F / 2x1/2	171A3551	171A3561	171A3571OM3	171A3571OM4
2	LC-Duplex / 48ch / 96F / 8x1/4	172A3113	172A3123	172A3133OM3	172A3133OM4
	LC-Duplex / 48ch / 96F / 4x1/2	172A3151	172A3161	172A3171OM3	172A3171OM4
	SC-Duplex / 48ch / 96F / 8x1/4	172A3413	172A3423	172A3433OM3	172A3433OM4
	SC-Duplex / 48ch / 96F / 4x1/2	172A3451	172A3461	172A3471OM3	172A3471OM4
	E-2000®-Compact / 48ch / 96F / 8x1/4	172A3513	172A3523	172A3533OM3	172A3533OM4
	E-2000®-Compact / 48ch / 96F / 4x1/2	172A3551	172A3561	172A3571OM3	172A3571OM4

With other adapter types and numbers of channels/fibers on request.

SMAP-G2 SD 24 fiber splice module:

Properties:

- Fits only into 300 mm deep panels
- Ready for splicing, factory assembled with colored buffered fiber pigtails, fibers same colors as buffers
- Fiber length 2.0 meter
- Without splice protectors and splice holders, they must be ordered separately, see product information 19" panel accessories
- Inclusive PG13.5 cable gland for cable diameter 6 to 12 mm within back plane
- Height: 1 HU
- Width: 1/4
- Depth without cable gland: 201 mm
- Toolless placement of the splice module into the panel from the front side, fixing with quick fasteners
- Material and colour:
 - - module body: aluminum powder coated RAL9005 black
 - - Front: steel powder coated RAL9005 black

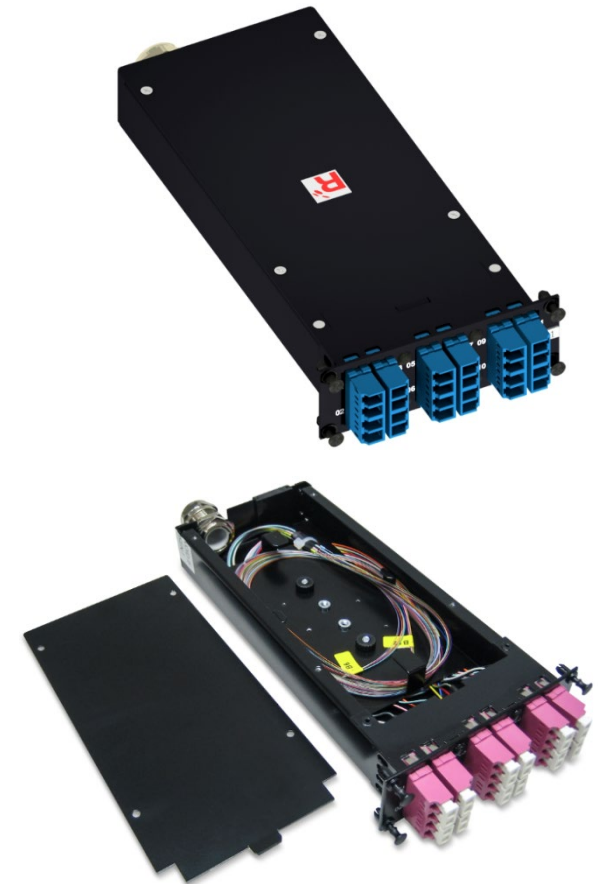

Part numbers RAL9005 black			
Number of LC-Duplex ports at front side	OM4	SM LC-PC 0°	SM LC-APC 8°
12	170A2040OM4	170A2041	170A2042

SMAP-G2 SD back planes, steel powder coated RAL9005 black:

Blind back plane



Part number 170A1501

With 12 PreCONNECT® square interfaces



Part number 170A1502

With 16 PreCONNECT® square interfaces



Part number 170A1503

Modular back plane 2x3

Right and left one toolless mountable plate with each 3 PreCONNECT® square interfaces.
3 fixed PreCONNECT® square interfaces in the center.



Part number 170A1520

Modular back plane 4x1

4 toolless mountable plate with each 1 PreCONNECT® square interface.



Part number 170A1521

Z back plane with 4 PreCONNECT® square interfaces cable routing towards inside



Part number 170A1512

Z back plane with 4 PreCONNECT® square interfaces cable routing towards outside

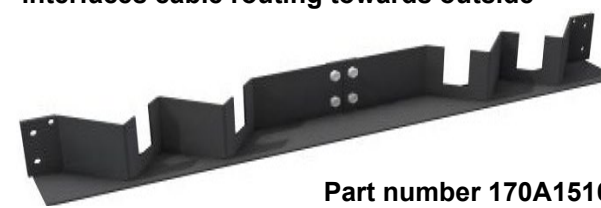

Part number 170A1516

SMAP-G2 SD back planes, steel powder coated RAL9005 black:

For universal fixing of cables with cable ties

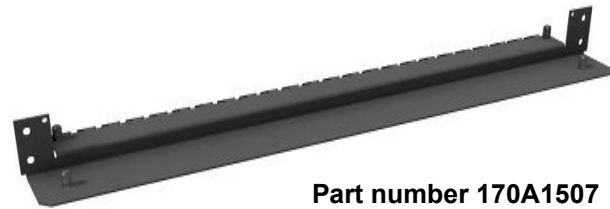

Part number 170A1507

Z back plane with 2 PreCONNECT® square interfaces on the left, cable routing towards inside. Universal fixing of cables with cable ties on the right.

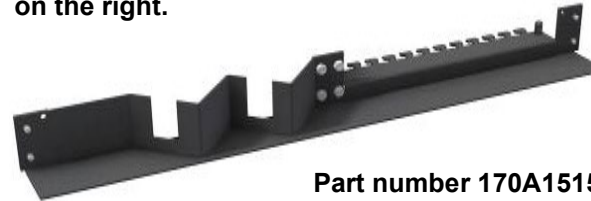

Part number 170A1515

Z back plane with 2 PreCONNECT® square interfaces on the right, cable routing towards inside. Universal fixing of cables with cable ties on the left.

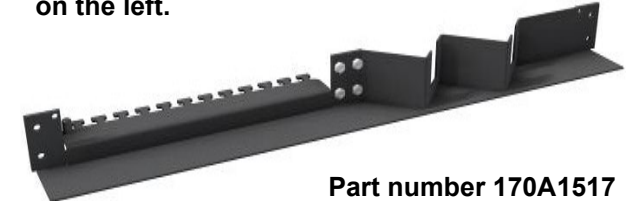

Part number 170A1517

With 8 holes diameter 29mm fitting for PG21 cable glands

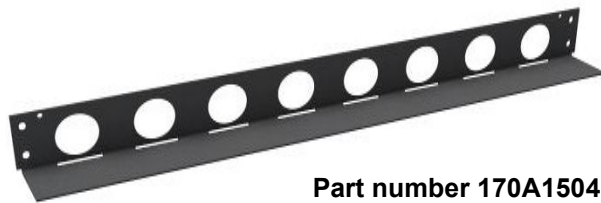

Part number 170A1504

Z back plane with 2 PreCONNECT® square interfaces on the left, cable routing towards outside. Universal fixing of cables with cable ties on the right.

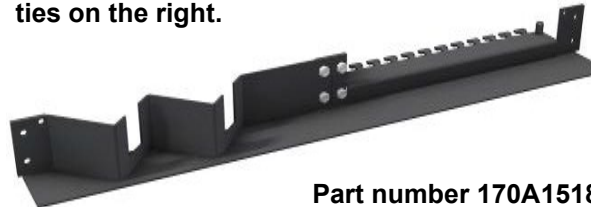

Part number 170A1518

Z back plane with 2 PreCONNECT® square interfaces on the right, cable routing towards outside. Universal fixing of cables with cable ties on the left.

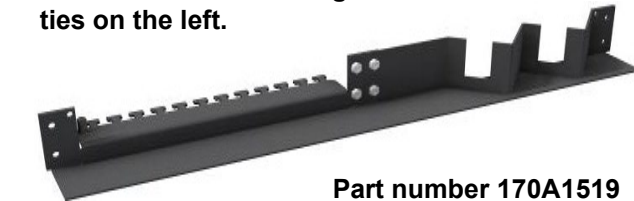

Part number 170A1519

Splice panel back plane:

With 6 holes diameter 29 mm, fitting for PG21 cable glands.

Capacity for 4 splice cassettes.

Incl. splice cassette cover, not shown.

Part number 170A1505

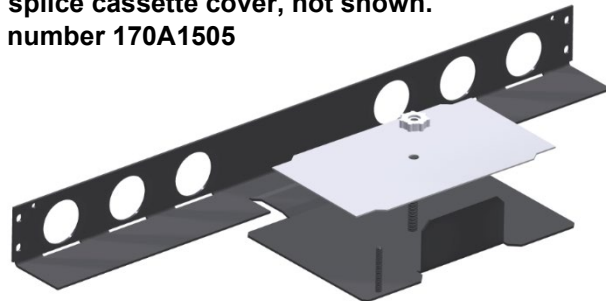

Splice cassette module to stack up to 4 splice cassettes at the splice panel back plane shown on the left, within panels higher than 1 HU.

Part number 170A1506

Example 2HU with 2x 4 splice cassettes



Patchcords:

Properties:

- Kink and crush resistance optimized for environmental conditions
- Operating temperature range: -10°C to +60°C
- Polarity:
- Full-duplex cables with duplex connectors on both sides “crossed” A to B in accordance with ISO/IEC 11801 and EN 50173

Length tolerances:

- Up to 1 m = - 50 mm
- 2 m to 3 m = - 100 mm
- 4 m to 25 m = - 200 mm
- Longer than 25 m = - 1 %

Delivery form:

- Attenuation (IL) measured in accordance with IEC 61300-3-4 „C“ or „Substitution“ method, MM 850nm/SM 1310nm, measurement values on request, or can be downloaded from our website by using the serial numbers of the patchcords <https://www.rosenberger.com/products/download-measurement-data/>
- Serial number labels with length information at both patchcord ends
- Individually packaged in foil bags with product ID label

For our SMAP-G2 HD and SMAP-G2 UHD 19" panel systems only patchcords with diameter 2.0mm or thinner should be applied.



With LC-COMPACT (LCC) connectors for SMAP-G2 SD 19" panel system

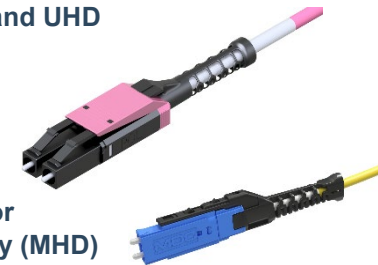

With LC-COMPACT Push-Pull-Boot (LCC-PPB) connectors for SMAP-G2 HD and UHD 19" panel system

MDC connector for Mega High Density (MHD)

Part numbers Duplex patchcord cable type round I-V(ZN)H and I-V(ZN)H(ZN)H FRNC-LSZH					
Cable diameter	Connectors	Length	OM4	OS2 PC 0°	OS2 APC 8°
1.6 mm	MDC » MDC	variable	092A0010OM4	092A0009G657A1	on request
	MDC » LC-COMPACT PPB	variable	092A0012OM4	092A0011G657A1	on request
	LC-COMPACT PPB » LC-COMPACT PPB	variable	087A6949OM4	087A6948G657A1	087A6950G657A1
2.0 mm	LC-COMPACT » LC-COMPACT	variable	087A6623OM4	087A6620G657A1	087A6622G657A1
	LC-COMPACT PPB » LC-COMPACT PPB	variable	087A6737OM4	087A6738G657A1	087A6747G657A1
	MDC » MDC	variable	092A0004OM4	092A0003G657A1	on request
	MDC » LC-COMPACT	variable	092A0008OM4	092A0007G657A1	on request
	MDC » LC-COMPACT PPB	variable	092A0008OM4	092A0007G657A1	on request
	LC-COMPACT » LC-COMPACT	variable	087A6601OM4	087A6600G657A1	087A6609G657A1
2.8 mm	LC-COMPACT PPB » LC-COMPACT PPB	variable	087A6753OM4	087A6754G657A1	087A6755G657A1
	LC-COMPACT » LC-COMPACT	variable	087A6613OM4	087A6610G657A1	087A6612G657A1
double jacket 2.8 / 5.0 mm	LC-COMPACT PPB » LC-COMPACT PPB	variable	087A6759OM4	087A6760G657A1	087A6761G657A1

Technical data of connectors, fibers and cables on request via the product profile of your selected patchcords.

Patchcords:



Part numbers
Duplex patchcords cable type Zipcord I-V(ZN)H 2 x 2.1 mm FRNC-LSZH

Connectors	Length	SM	OM4
LC-Duplex » LC-Duplex	variable	087A5005G657A1	087A5015OM4
LC-Duplex » SC-Duplex	variable	087A5035G657A1	087A5045OM4

With other connectors and fiber types on request.

Part numbers
Duplex patchcords cable type Zipcord I-V(ZN)H 2 x 2.8 mm FRNC-LSZH

Connectors	Length	SM	OM4
SC-Duplex » SC-Duplex	variable	062A0180G657A1	062A0160OM4
SC-Duplex » LC-Duplex	variable	087A2068G657A1	087A2078OM4
E-2000® HRL Simplex » E-2000® HRL Simplex	variable	069A2200G657A1	-

With other connectors and fiber types on request.

Part numbers
Duplex patchcords cable type double-jacket flat-breakout I-V(ZN)HH 2 x 2.1 mm FRNC-LSZH

Connectors	Length	SM	OM4
LC-Duplex » LC-Duplex	variable	087A1900G657A1	087A1911OM4
LC-Duplex » SC-Duplex	variable	087A2000G657A1	087A2079OM4
E-2000® HRL Simplex » E-2000® HRL Simplex	variable	069A2202G657A1	-

With other connectors and fiber types on request.

Part numbers
Duplex patchcords cable type double-jacket flat-breakout I-V(ZN)HH 2 x 2.8 mm FRNC-LSZH

Connectors	Length	SM	OM4
SC-Duplex » SC-Duplex	variable	062A0179G657A1	062A0159OM4
SC-Duplex » LC-Duplex	variable	087A2069G657A1	087A2011OM4
E-2000® HRL Simplex » E-2000® HRL Simplex	variable	069A2201G657A1	-

With other connectors and fiber types on request.

For 19" panel accessories see our product information 19" panel accessories:



Labeling fields



Patchcord manager

- height units saving (0 HU) mountable in front of 19" panels
- with foldaway front cover
- with optional labelling and port address fields

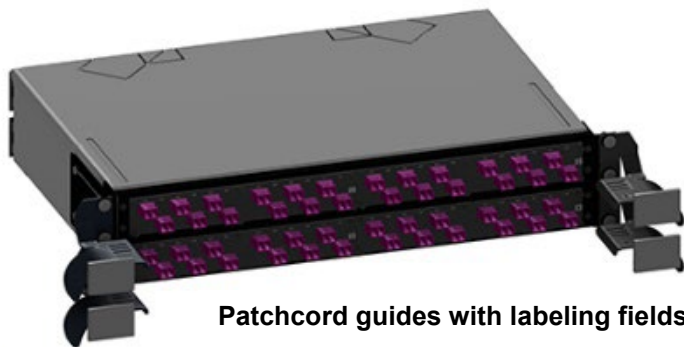

Patchcord guides with labeling fields



About Rosenberger OSI:

Since 1991, Rosenberger Optical Solutions & Infrastructure (Rosenberger OSI) has been a recognized expert for fiber-based connectivity, cabling solutions and infrastructure services in the areas of data centers, local area networks, mobile networks and industrial applications. As an integrated solution provider, we have high expertise in the development and operational excellence in the production of system solutions for communication networks. Our comprehensive services enable the secure and efficient operation of digital infrastructures. This combination, combined with our strong customer focus, makes us unique and a strong partner in the global market.

Rosenberger OSI has been part of the globally operating Rosenberger Group since 1998. The Rosenberger Group is a leading global provider of high-frequency, high-voltage and fiber optic connectivity solutions with headquarters in Germany. For further information, please visit:

www.rosenberger.com/osi

Rosenberger

Rosenberger-OSI GmbH & Co. OHG

Optical Solutions & Infrastructure | Endorferstr. 6 | 86167 Augsburg | Telefon: +49 821 24924-0
info-osi@rosenberger.com | www.rosenberger.com/osi

Rosenberger® is a registered trademark of Rosenberger Hochfrequenztechnik GmbH & Co. KG. All rights reserved. © Rosenberger 2017

For technical reasons, we reserve us the right to make any deviations from the illustrations in the product information.
Transfer to third party only by authority of Rosenberger-OSI GmbH & Co. OHG- All rights reserve.

Creation date: 2019-09-13

Valid since: 2022-11-07

Revision: 012