

## PRODUCTPROFILE

**Catalogue number: 094A0002G657A1-5000**

Partnumber: 20104637

---

Fiber optic duplex patchcord  
Connector side A: CS EZ-Flip SM  
Connector side B: LC-COMPACT Push Pull Boot  
SM  
9/125µm,  
I-V(ZN)H2F2,0  
length: 5,0m  
Polarity: crossed A to B

**Related documents:**

DS_CS-EZFLIP_STECKER_OE	Steckerdatenblatt
DS_FASER G657A1_OE	Fiber Data Sheet
DS_I-VZNH20_2X600_L_OE	Cable Data Sheet
DS_LC_COMPACT_PPBNB_STECKER_C	Steckerdatenblatt

CS® EZ-Flip connector

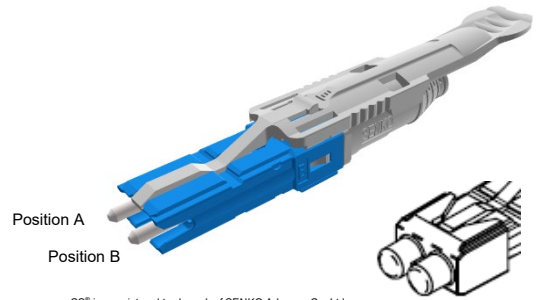
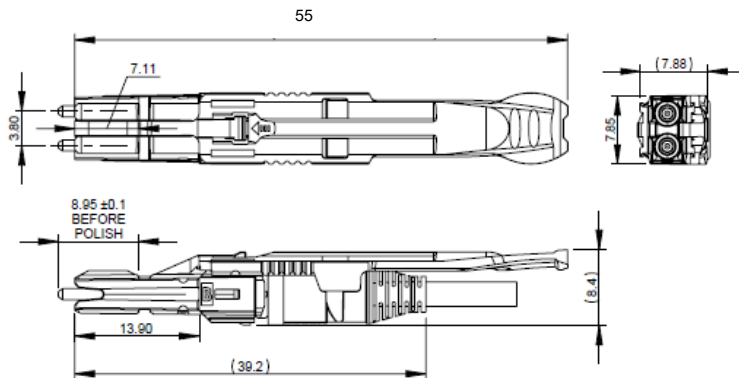

CS® is a registered trademark of SENKO Advance Co. Ltd.

Properties and applications

- CS® (Connector Senko) EZ-Flip of category Very-Small-Form-Faktor (VSFF) connector
- Even of its miniature design the connector has a rugged housing with central strain relief and push-pull-tab, with which the connector can be plugged and un-plugged
- A/B polarity easy and secure, toolless changeable
- To attach transceivers with CS® interface and for infrastructure cabling

Standards

TIA-604-19 (in this standard the CS® is called SEN)

Material

- Ferrule: Zirconia ceramic, Ø 1.25 mm
- Body: Plastic, flammability UL94-V0
- Push-Pull-Tab: Plastic, flammability UL94-V0
- Protection cap: Plastic, flammability UL94-V0

Optical properties

The quality feature of the connector at your product is identified by the part number:

- BASIC: Part numbers like XXXAXXXX
- PURE: Part numbers with "P" at their end, XXXAXXXXP

Details about PURE see Produktinfo\_Qualitätsmerkmal-PURE\_od

Insertion Loss IL acc. to IEC61300-3-4, Method B, against reference, maximum [dB]:

	Quality feature	BASIC	PURE
- Singlemode SM, 9/125µm		0.30	0.20
- Multimode OM1, 62.5/125µm		0.30	---
- Multimode low IL OM2, OM3, OM4, OM5, 50/125µm		0.15	0.15

Insertion Loss IL „random mated“ acc. to IEC61300-3-34, Method 2, [dB]:

Quality feature	BASIC	mean value	maximum
- Singlemode SM, 9/125µm		0.13	0.50
- Multimode low IL OM2, OM3, OM4, OM5, 50/125µm		0.03	0.27

Insertion Loss IL quality feature PURE "random mated" application limit value, maximum [dB]:

- Singlemode SM, 9/125µm	97%	0.25
- Multimode low IL OM2, OM3, OM4, OM5, 50/125µm	100%	0.40

Dieses Dokument ist urheberrechtlich geschützt • This document is protected by copyright • Rosenberger OSI GmbH & Co. OHG

CS® EZ-Flip connector

Optical properties

Return Loss RL acc. to IEC61300-3-6, Method 1, against reference, minimum [dB]:

	Quality feature	BASIC	PURE
- Singlemode SM, 9/125µm, PC 0°		45	45
- Singlemode SM, 9/125µm, UPC 0°		55	55
- Singlemode SM, 9/125µm, APC 8°		65	70
- Multimode all classes		35	40

Mechanical properties

- Mating cycles min. 500, IL increase < 0.2 dB
- Strain relief max. 100 N, dependent on cable type

Thermal properties

- Operation temperature range -40°C to +85°C, dependent on cable type
- Storage temperature range -40°C to +85°C

Cable diameters

Round cable types Ø 2.0 to 3.0 mm

Colors

Connector body / boot:

- Singlemode SM, 9/125µm, PC and UPC 0° blue / white
- Singlemode SM, 9/125µm, APC 8° green / white
- Multimode OM4, 50/125µm violet / white

Polarity change

Source [www.senko.com](http://www.senko.com)

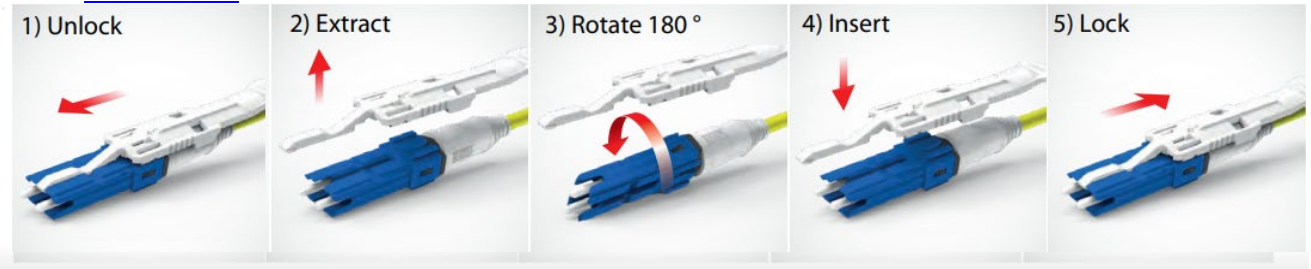

While the information has been carefully compiled to the best of our knowledge, nothing is intended as representation or warranty on our part and no statement herein shall be construed as recommendation to infringe existing patents. In the effort to improve our products, we reserve the right to make changes judged to be necessary.

For the installation of the electrotechnical equipment, particular electrotechnical expertise is required.



Dieses Dokument ist urheberrechtlich geschützt • This document is protected by copyright • Rosenberger-OSI GmbH & Co. OHG

Draft	Date	Approved	Date	Rev.	Engineering change number	Name	Date
H. Jungbäck	2023-07-03	S. Gleich	2023-07-03	001	---	---	---

Rosenberger-OSI GmbH & Co. OHG Endorferstr. 6   86167 Augsburg   Germany <a href="http://www.rosenberger.com/osi">www.rosenberger.com/osi</a>	Tel. : +49 821 249249-0 E-Mail : <a href="mailto:info-osi@rosenberger.com">info-osi@rosenberger.com</a>	Page 2 / 2
---	--	---------------

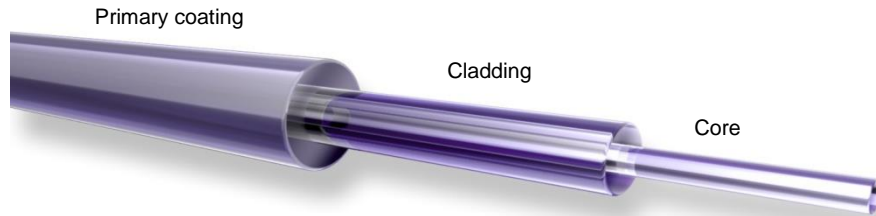

**Standards**

Stepped index fiber 9/125µm according to  
 -ISO/IEC 11801 und EN 50173-1 OS2  
 -IEC 60793-2-50 type B1.3  
 -ITU G.657.A1 und G.652.D

**Structure**

Silica fiber with two layer acrylate primary coating

**Geometrical properties**

Modefield diameter @1310 nm	9.2 µm +/- 0.4 µm
Modefield diameter @1550 nm	10.4 µm +/- 0.5 µm
Cladding diameter	125 µm +/- 0.07 µm
Cladding non-circularity	≤ 0.7 %
Core-Cladding concentricity	≤ 0.5 µm
Primary coating diameter	242 µm +/- 5 µm
Coating-Cladding concentricity	< 12 µm

**Mechanical properties**

Break strength SCREEN-Test 1 % strain for 1 s @100 kpsi

**Thermal properties**

Operating temperature range -60 to +85°C

Dieses Dokument ist urheberrechtlich geschützt • This document is protected by copyright • Rosenberger OSI GmbH & Co. OHG

**Transmission characteristics**

**Attenuation:**

- Cabled fiber tight buffered:** @ 1310 nm max. 0.38 dB/km  
@ 1550 nm max. 0.28 dB/km
- Cabled fiber loose tube:** @ 1310 nm max. 0.36 dB/km  
@ 1550 nm max. 0.22 dB/km
- Uncabled fiber:** @ 1310 nm max. 0.32 dB/km  
@ 1383 nm max. 0.32 dB/km  
@ 1490 nm max. 0.21 dB/km  
@ 1550 nm max. 0.18 dB/km  
@ 1625 nm max. 0.20 dB/km

**Macrobending, induced attenuation, uncabled fiber:**

- Radius 10 mm, 1 turn, @ 1550 nm ≤ 0.50 dB
- Radius 10 mm, 1 turn, @ 1625 nm ≤ 1.50 dB
- Radius 15 mm, 10 turns, @ 1550 nm . 0.05 dB
- Radius 15 mm, 10 turns, @ 1625 nm ≤ 0.30 dB
- Radius 25 mm, 100 turns, @ 1310, 1550 und 1625 nm ≤ 0.01 dB

**Dispersion:**

- @ 1285 - 1330 nm ≤ 3.0 ps/(nm\*km)
- @ 1550 nm ≤ 18.0 ps/(nm\*km)
- @ 1625 nm ≤ 22.0 ps/(nm\*km)

**Polarization Mode Dispersion (PMD):**

- PMD Link Design Value ≤ 0.04 ps/√km
- Maximum individual fiber PMD ≤ 0.1 ps/√km

**Cut-off-Wavelength:** ≤ 1260 nm

**Effective group index of refraction:**

- @ 1310 nm 1.4676
- @ 1550 nm 1.4682

**Backscatter attenuation @ 1ns pulse width:**

- @ 1310 nm -77 dB
- @ 1550 nm -82 dB
- @ 1625 nm -83 dB

While the information has been carefully compiled to the best of our knowledge, nothing is intended as representation or warranty on our part and no statement herein shall be construed as recommendation to infringe existing patents. In the effort to improve our products, we reserve the right to make changes judged to be necessary.

Draft	Date	Approved	Date	Rev.	Engineering change number	Name	Date
H. Jungbäck	12-04-15	P. Maier	12-04-15	001	without	H. Jungbäck	12-04-15

Fiber Optic Cable  
I-V(ZN)H 2.0mm 2x600

032AXXXX

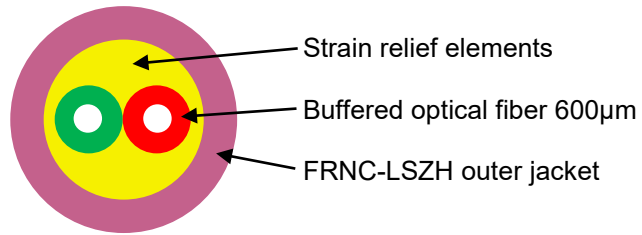

**Standards**

-IEC 60794-2

**Structure**

Cable:

- 2 buffered optical fibers 600µm within the cable jacket filled with Aramid strain relief elements
- Buffered fiber color code: One buffered fiber red, the other buffered fiber at singlemode yellow, at 50µm multimode green

Outer jacket:

- FRNC-LSZH flame-retardant and halogen-free material
- Standard jacket colors:
  - Singlemode: yellow
  - Multimode OM2: orange or green
  - Multimode OM3: aqua (turquoise)
  - Multimode OM4: violet
  - Multimode OM5: fibrous green
- Wall thickness 0.3 mm
- Inkjet marking black acc. to separate drawing

**Geometrical properties**

Number of fibers	Outer diameter [mm]	Weight [kg/km]	Fire load [MJ/m]
2	2.0	4	0.11

Dieses Dokument ist urheberrechtlich geschützt • This document is protected by copyright • Rosenberger OSI GmbH & Co. OHG

**Mechanical properties**

- Min. bending radius fixed (static):
  - with G.657.A1 bend-insensitive singlemode fiber 10 mm
  - with bend-insensitive OM3 and OM4 fiber 7.5 mm
- Min. bending radius during installation (dynamic):
  - with G.657.A1 bend-insensitive singlemode fiber 30 mm
  - with bend-insensitive OM3 and OM4 fiber 25 mm
- Max. tensile force short term = 300 N
- Max. crush resistance long term = 150 N/dm
- Kink resistance: Equivalent loop diameter = 8.4 mm

**Thermal properties**

- Transport and storage - 25°C to + 70°C
- Installation - 5°C to + 50°C
- In use - 5°C to + 70°C

**Chemical properties**

- No resistance to oil, petrol, acid, leach and water

**Fire performance**

- Flame-retardant acc. to IEC 60332-1-2
- Smoke density acc. to IEC 61034
- Halogen-free acc. to IEC 60754-1
- Acidity of the combustion gases acc. to IEC 60754-2

**Transmission characteristics**

- See fiber data sheets

**Applications**

- Indoor cable particularly appropriate for short LC-Compact and MU-Compact Patchcords

**Deliveryform**

- On one-way drums

While the information has been carefully compiled to the best of our knowledge, nothing is intended as representation or warranty on our part and no statement herein shall be construed as recommendation to infringe existing patents. In the effort to improve our products, we reserve the right to make changes judged to be necessary.

Draft	Date	Approved	Date	Rev.	Engineering change number	Name	Date
H. Jungbäck	2016-02-02	P. Maier	2016-02-02	003	without	H. Jungbäck	2021-08-25

LC-COMPACT Push-Pull-Boot Connector Next Generation

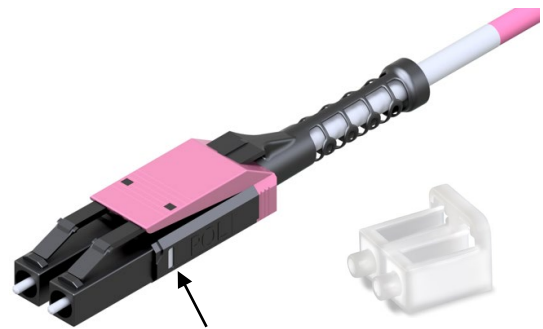
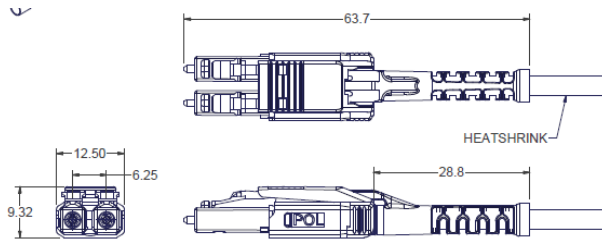

Delivery status of polarity window POL:  
 - at this connector side (B) = white  
 - at the opposite connector side (A) = black

Properties and applications

- LC-Duplex Push-Pull connector with compact and rugged backshell with central strain relief and push-pull-boot, with which the connector can be plugged and un-plugged
- A/B polarity easy and secure, toolless changeable
- For HIGH-DENSITY (HD) and ULTRA-HIGH-DENSITY (UHD) applications required
- Translucence duplex protection cap, fast and secure to handle and permeable for the light of laser pointers (visual fault locators)

Standards

LC-Duplex acc. to IEC/DINEN 61754-20 and EIA/TIA 604-10

Material

- Ferrule: Zirconia ceramic, Ø 1.25 mm
- Body: PA, PBT and PTFE, flammability UL94-V0
- Push-Pull-Boot: PP, flammability UL94-V0
- Protection cap: TPE, flammability UL94-HB

Optical properties

The quality feature of the connector at your product is identified by the part number:

- BASIC: Part numbers like XXXAXXXX
- PURE: Part numbers with "P" at their end, XXXAXXXXP

Details about PURE see Produktinfo\_Qualitätsmerkmal-PURE\_od

Insertion Loss IL acc. to IEC61300-3-4, Method B, against reference, maximum [dB]:

	Quality feature	BASIC	PURE
- Singlemode SM, 9/125µm		0.30	0.20
- Multimode OM1, 62.5/125µm		0.30	---
- Multimode low IL OM2, OM3, OM4, OM5, 50/125µm		0.15	0.15

Insertion Loss IL „random mated“ acc. to IEC61300-3-34, Method 2, [dB]:

Quality feature	BASIC	mean value	maximum
- Singlemode SM, 9/125µm		0.13	0.50
- Multimode low IL OM2, OM3, OM4, OM5, 50/125µm		0.03	0.27

Insertion Loss IL quality feature PURE “random mated” application limit value, maximum [dB]:

- Singlemode SM, 9/125µm	97%	0.25
- Multimode low IL OM2, OM3, OM4, OM5, 50/125µm	100%	0.40

**GHMT PVP certificate**  
 No.: c6997X-XX  
 No.: c6998X-XX



Dieses Dokument ist urheberrechtlich geschützt • This document is protected by copyright • Rosenberger OSI GmbH & Co. OHG



LC-COMPACT Push-Pull-Boot Connector Next Generation

**Optical properties**

Return Loss RL acc. to IEC61300-3-6, Method 1, against reference, minimum [dB]:

	Quality feature	BASIC	PURE
- Singlemode SM, 9/125µm, PC 0°		45	45
- Singlemode SM, 9/125µm, UPC 0°		55	55
- Singlemode SM, 9/125µm, APC 8°		65	70
- Multimode all classes		35	40

**Mechanical properties**

- Mating cycles	min. 500, IL increase < 0.2 dB
- Strain relief	max. 100 N, dependent on cable type

**Thermal properties**

- Operation temperature range	-40°C to +85°C, dependent on cable type
- Storage temperature range	-40°C to +85°C

**Cable diameters**

Round cable types	Ø 2.0 to 3.0 mm
-------------------	-----------------

**Colors**

Connector body / boot:

- Singlemode SM, 9/125µm, PC and UPC 0°	black and blue / black
- Singlemode SM, 9/125µm, APC 8°	black and green / black
- Multimode OM3, 50/125µm	black and aqua / black
- Multimode OM4, 50/125µm	black and violet / black

**Polarity change**

See our video



While the information has been carefully compiled to the best of our knowledge, nothing is intended as representation or warranty on our part and no statement herein shall be construed as recommendation to infringe existing patents. In the effort to improve our products, we reserve the right to make changes judged to be necessary.

Gezeichnet	Datum	Freigegeben	Datum	Rev.	Änderungsnummer	Name	Datum
H. Jungbäck	2022-01-20	R. Mees	2022-01-20	003	---	H. Jungbäck	2022-10-07