

PRODUCTPROFILE

Catalogue number: 036A05100M4

Partnumber: 748537

PreCONNECT® BREAKOUT TRUNK
4 channels, 8 fibers, 50/125µmOM4, violet
with square-interfaces
Connector side A: LC-Compact MM
Connector side B: LC-Compact MM
Cable I-V(ZN)HH6x2G50/125µm,OM4



Related documents:

DS_FASER OM4BI_OE	Fiber Data Sheet
DS_I-VZNNHXX2X900X28_L_OE	Kabeldatenblatt
DS_LC_COMPACT_STECKER_SHORT_C	Steckerdatenblatt
PRECONNECT_BREAKOUT_OE	Product Information

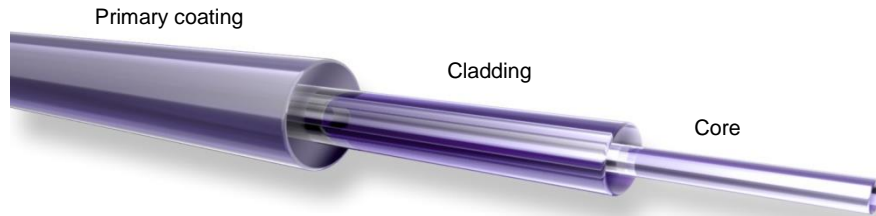

Standards

Graded index fiber 50/125µm according to
 -ISO/IEC 11801 und EN 50173-1 OM4
 -IEC 60793-2-10 type A1a.3
 -ITU G.651.1
 -TIA/EIA 492AAAD

Structure

Silica fiber with two layer acrylate primary coating

Geometrical properties

Core diameter	50 µm +/- 2.5 µm
Cladding diameter	125 µm +/- 1 µm
Core non-concentricity	< 5 %
Cladding non-circularity	< 1 %
Core-Cladding concentricity	< 1.5 µm
Primary coating diameter	242 µm +/- 5 µm
Coating-Cladding concentricity	< 12 µm

Mechanical properties

Break strength SCREEN-Test 1 % strain for 1 s @100 kpsi

Thermal properties

Operating temperature range -60 to +85°C

Dieses Dokument ist urheberrechtlich geschützt • This document is protected by copyright • Rosenberger OSI GmbH & Co. OHG

Optical fiber OM4
bend insensitive

059A0381OM4BI

Transmission characteristics

Attenuation:

@ 850 nm max. 2.3 dB/km
@ 1300 nm max. 0.6 dB/km

Macrobending, induced attenuation:

100 turns, 37.5 mm \leq 0.05 dB @ 850 nm
100 turns, 37.5 mm \leq 0.15 dB @ 1300 nm
2 turns, 15 mm \leq 0.1 dB @ 850 nm
2 turns, 15 mm \leq 0.3 dB @ 1300 nm
2 turns, 7.5 mm \leq 0.2 dB @ 850 nm
2 turns, 7.5 mm \leq 0.5 dB @ 1300 nm

Bandwidth (Overfilled launch):

@ 850 nm min. 3500 MHz x km
@ 1300 nm min. 500 MHz x km

Effective modal Bandwidth-length-product (EMB):

@ 850 nm min. 4700 MHz x km

Numerical aperture: 0.200 +/- 0.015

Effective group index of refraction:

@ 850 nm 1.480
@ 1300 nm 1.479

Backscatter attenuation @ 1ns pulse width:

@ 850 nm -68 dB
@ 1300 nm -76 dB

Maximum possible transmission channels lengths:

Ethernet:

1 GBE 1000BASE-SX: min. 1100 m @ max. 3.56 dB channel attenuation ¹⁾
10 GBE 10GBASE-SR: min. 550 m @ max. 2.60 dB channel attenuation ¹⁾
40 GBE 40GBASE-SR4: min. 170 m @ max. 1.50 dB channel attenuation ¹⁾
100 GBE 100GBASE-SR10: min. 170 m @ max. 1.50 dB channel attenuation ¹⁾

Fibre Channel:

8 GFC (800-SN): min. 245 m @ max. 1.76 dB channel attenuation ¹⁾
16 GFC (1600-SN): min. 165 m @ max. 1.51 dB channel attenuation ¹⁾

¹⁾ Inclusive max. 1.0 dB for connections (connectors and splices)

While the information has been carefully compiled to the best of our knowledge, nothing is intended as representation or warranty on our part and no statement herein shall be construed as recommendation to infringe existing patents. In the effort to improve our products, we reserve the right to make changes judged to be necessary.

Draft	Date	Approved	Date	Rev.	Engineering change number	Name	Date
H. Jungbäck	26-10-15	P. Maier	26-10-15	004	without	H. Jungbäck	26-10-15

Fiber Optic Cable
I-V(ZN)HH n x 2 x 900 x 2.8

036AXXXX

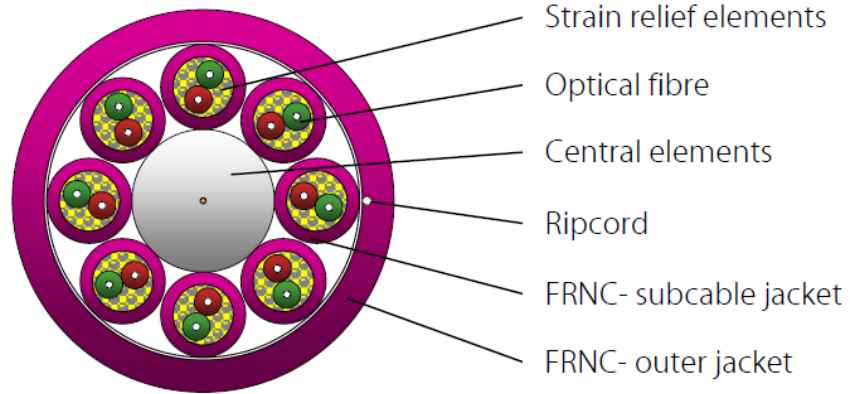

Standards

-IEC 60794-2-20

Structure

Subcable:

- 2 buffered optical fibers 0.9mm within a subcable filled with Aramid strain relief elements with outer diameter 2.8 mm, numbering 1 to n
- Buffered fiber color code: Multimode 50/125µm = red and green; Singlemode 9/125µm = red and yellow
- Jacket material FRNC-LSZH flame-retardant and halogen-free, wall thickness 0.4 mm

Stranding:

- Subcable stranded in one layer over central element

Outer jacket:

- FRNC-LSZH flame-retardant and halogen-free material

-Standard jacket colors:

- Singlemode: yellow
- Multimode OM2: orange or green
- Multimode OM3: aqua (turquoise)
- Multimode OM4: violet

- Ripcord below jacket
- Inkjet marking black acc. to separate drawing

Geometrical properties

Number of Subcables	Number of fibers	Outer diameter [mm]	Outer jacket wall thickness [mm]	Weight [kg/km]	Max. tensile force acc. to IEC 60794-1-2 E1 [N]
6	12	10.5	0.9	100	800
8	16	12.6	1.1	154	1000
12	24	16.5	1.3	270	1200

Dieses Dokument ist urheberrechtlich geschützt • This document is protected by copyright • Rosenberger OSI GmbH & Co. OHG

Fiber Optic Cable
I-V(ZN)HH n x 2 x 900 x 2.8

036AXXXX

Mechanical properties

- Min. bending radius fixed (static) acc. IEC 60794-1-2 E11A
10 x outside diameter
- Min. bending radius during installation (dynamic) with additional tensile strain acc. IEC 60794-1-2 E6
15 x outside diameter
- Max. crush resistance acc. IEC 60794-1-2 E3 long term = 1000 N/dm

Thermal properties

- Transport and storage - 25°C to + 70°C
- Installation - 5°C to + 50°C
- In use acc. IEC 60794-1-2 F1 - 10°C to + 70°C

Chemical properties

No resistance to oil, petrol, acid, leach and water

Fire performance

- Flame-retardant acc. to IEC 60332-1-2 and IEC 60332-3-22 Cat. A
- Smoke density acc. to IEC 61034
- Halogen-free acc. to IEC 60754-1
- Acidity of the combustion gases acc. to IEC 60754-2

Transmission characteristics

See fiber data sheets

Applications

- Breakout indoor cable particularly appropriate for direct assembling of LC-COMPACT, MU-COMPACT and other so called UNIBOOT connectors
- Installation in raised-floors and cable trays

Deliveryform

On one-way drums

While the information has been carefully compiled to the best of our knowledge, nothing is intended as representation or warranty on our part and no statement herein shall be construed as recommendation to infringe existing patents. In the effort to improve our products, we reserve the right to make changes judged to be necessary.

Draft	Date	Approved	Date	Rev.	Engineering change number	Name	Date
H. Jungbäck	2018-01-25	P. Maier	2018-01-25	001	without	---	---

LC-COMPACT Shortboot connector

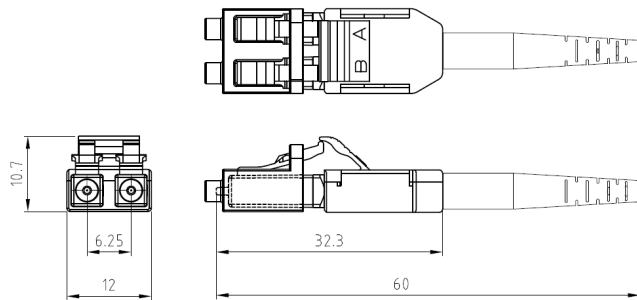

Properties and applications

- LC-Duplex connector with compact and rugged backshell with short central strain relief and boot for round cable (Uniboot)
- A/B polarity can be easily tool-less changed
- The short boot enables the use of the connector in applications with low depth, like ODF Optical Distribution Frames
- Translucence duplex protection cap, fast and secure to handle and permeable for the light of laser pointers (visual fault locators)

Standards

LC-Duplex acc. to IEC/DINEN 61754-20 and EIA/TIA 604-10

Material

- Ferrule: Zirconia ceramic, Ø 1.25 mm
- Body: PEI, flammability UL94-V0
- Boot: TPE, flammability UL94-V0
- Protection cap: POM, flammability UL94-HB

Optical properties

The quality feature of the connector at your product is identified by the part number:

- BASIC: Part numbers like XXXAXXXX
- PURE: Part numbers with "P" at their end, XXXAXXXXP

Details about PURE see Produktinfo_Qualitätsmerkmal-PURE_od

Insertion Loss IL acc. to IEC61300-3-4, Method B, against reference, maximum [dB]:

	Quality feature	BASIC	PURE
- Singlemode SM, 9/125µm		0.30	0.20
- Multimode OM1, 62.5/125µm		0.30	---
- Multimode low IL OM2, OM3, OM4, OM5, 50/125µm		0.15	0.15

Insertion Loss IL „random mated“ acc. to IEC61300-3-34, Method 2, [dB]:

Quality feature	BASIC	mean value	maximum
- Singlemode SM, 9/125µm		0.13	0.50
- Multimode low IL OM2, OM3, OM4, OM5, 50/125µm		0.03	0.27

Insertion Loss IL quality feature PURE "random mated" application limit value, maximum [dB]:

- Singlemode SM, 9/125µm	97%	0.25
- Multimode low IL OM2, OM3, OM4, OM5, 50/125µm	100%	0.40

GHMT PVP certificate
No.: c6997X-XX
No.: c6998X-XX



Dieses Dokument ist urheberrechtlich geschützt • This document is protected by copyright • Rosenberger OSI GmbH & Co. OHG

LC-COMPACT Shortboot connector

Optical properties

Return Loss RL acc. to IEC61300-3-6, Method 1, against reference, minimum [dB]:

	Quality feature	BASIC	PURE
- Singlemode SM, 9/125µm, PC 0°		45	45
- Singlemode SM, 9/125µm, UPC 0°		55	55
- Singlemode SM, 9/125µm, APC 8°		65	70
- Multimode all classes		35	40

Mechanical properties

- Mating cycles min. 1000, IL increase < 0.2 dB
- Strain relief max. 100 N, dependent on cable type

Thermal properties

- Operation temperature range -40°C to +85°C, dependent on cable type
- Storage temperature range -40°C to +85°C

Cable diameters

- Round cable types Ø 2.0 to 3.0 mm

Colors

Connector body / boot:

- Singlemode SM, 9/125µm, PC and UPC 0° blue / blue
- Singlemode SM, 9/125µm, APC 8° green / green
- Multimode OM1, 62.5/125µm beige / white
- Multimode OM2, OM3, OM4, OM5, 50/125µm black / black

Polarity change

1) Remove the connector top cover by inserting a fingernail or a small lever into the crack that separates the two halves.

2) Carefully swap position of the connectors by lifting them up and out of the bottom housing.

3) Reposition the top cover and snap into place.



While the information has been carefully compiled to the best of our knowledge, nothing is intended as representation or warranty on our part and no statement herein shall be construed as recommendation to infringe existing patents. In the effort to improve our products, we reserve the right to make changes judged to be necessary.

Draft	Date	Approved	Date	Rev.	Engineering change number	Name	Date
H. Jungbäck	2018-12-13	A. Burggraf	2018-12-13	009	----	H. Jungbäck	2022-10-07

PreCONNECT® BREAKOUT

PRODUCT INFORMATION



PreCONNECT® BREAKOUT solution is available in two end face quality features: BASIC and PURE**Define the end-face quality according to your application requirements:**

Quality feature BASIC is our well-proven, high-grade, standards compliant product in terms of end-face geometry, defect, and cleanliness, providing excellent IL and RL performance:

- The PreCONNECT® factory-assembled plug & play system enables quick and reliable, cost efficient, installation and performance
- Harmonized modular components of the quality feature BASIC solution ensure end to end performance of the entire channel

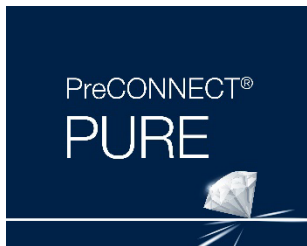

Quality feature PURE is the enhanced version of our quality feature BASIC, but with more stringent defect and cleanliness screening and factory sealed, tamper evident adapter-interfaces.

- Guaranteed protection of the polished connector end-face against contamination and damage through sealed adapter-interfaces, enabling time savings during initial installation and commissioning due to the elimination of the need for cleaning and testing*/**.
- Quality feature PURE provides an industry leading low random mate insertion and return loss (mean) which enables up to six (6) mated pairs in a 10G/OM4 application up to 300m.

Part numbers:

Quality feature BASIC: The part numbers XXXAXXXX listed in this document are valid for the BASIC quality feature.

Quality feature PURE: Add a "**P**" to the end of the quality feature BASIC part number (*Example: XXXAXXXX**P***)

(Note: PURE trunk cables have factory attached sealed coupling adapters incorporated and thus utilize empty patch panels and enclosures)

** While Rosenberger does not require permanent link or channel testing for warranty registration of PURE installations due to guaranteed performance, certain customers will require testing documentation for their records.*

*** Only applicable when all components are of quality feature PURE and installed by trained PURE installers.*

Applications:

Cabling of data centers and their IT rooms, data center containers and EDGE computing sites

System consists of:

- Factory assembled FO breakout cables, FRNC-LSZH indoor cables, up to 32 fibers
- With connector systems LC, MDC, SC and E2000™
- Three 19" panel systems selectable: Conventional distribution panels, SMAP-G2 SD, SMAP-G2 HD and SMAP-G2 UHD
- Suitable Patchcords
- Useful accessories
- Patch Location Rack



Features:

- For few numbers of fibers and short lengths:
 - Trunks up to 32 fibers
 - Practical lengths: Cost comparison by break-even calculation versus PreCONNECT® STANDARD
- Migration to MPO based parallel optics applications possible by using Migration-Harnesses

Your benefits at a glance:

- Most cost-effective solution for Trunks up to 32 fibers and short lengths
- Fast and safe installation through factory assembled Plug & Play systematic
- Highest quality and cost-efficiency through factory assembling
- PreCONNECT® cabling systems consist of perfectly harmonized modular single components

Applications:

Cabling of data centers and their IT rooms, data center containers and EDGE computing sites.

- **Universal to use FO cabling system up to 32 fibers per Trunk**
- **Cost and attenuation optimized**
- **Focused on the useful and necessary**

Properties:

PreCONNECT® square-interfaces on both sides which can be tool-less hooked into PreCONNECT® 19" Panels for tensile and torsion resistant fixing of the PreCONNECT® BREAKOUT Trunks.

Connector legs on both sides can be ordered application specific „variable“ all the same length, from 20cm to max. 5m, or as our „standard stepped“ fitting to our PreCONNECT® 19" Panels

Mixed configurations, ex. side A „standard stepped“ and side B „variable“ are possible too.

Polarity: The connector legs are alpha numerical uniquely coded. The standard polarity is „channelwise crossed“ (pairwise flipped) for full-duplex transmission systems – A1 to B1, A2 to B2, etc. On request „uncrossed“ deliverable.

Length definition: Order-length = length between the connectors of the longest legs at both sides, not between the PreCONNECT® square-interfaces.

Delivery form: Dependent on the length as cable ring or on cardboard or wooden drum, 100% IL factory measured with measurement protocol, product label with serial number on both sides.

System description:

Our PreCONNECT® BREAKOUT cabling system consists of:

- PreCONNECT® BREAKOUT Trunk called factory assembled FO breakout cables, can be ordered with application specific “variable” long connector legs
- therefore explicitly developed 19" Panel systems
- a large variety of Patchcords and accessories
- and Patch Location Racks

We consider Breakout-Trunks as an alternative product on short lengths and up to 32 fibers to our well established loose-tube cables based Trunks. Breakout-Trunks do not need cable dividers, since the connectors are directly assembled at the robust sub-elements of the breakout cables.

The „Break-Even-Length“ of Breakout-Trunks versus loose-tube cables based Trunks depends on the type. The cost reduction of the not needed cable dividers is equalized by the higher per meter price of Breakout-Trunks at certain lengths.

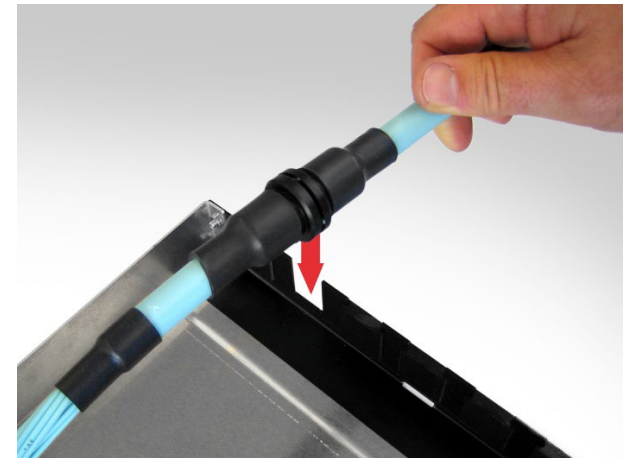

Properties:

Breakout cable types:

PreCONNECT® BREAKOUT Trunks are deliverable with all breakout cables up to 32 fibers, mostly used:

- Indoor cable I-V(ZN)HH, CPR class Dca, Cca and B2ca

Cable data, see separate cable data sheets.

Fiber types:

With all common fiber types deliverable.

Bend-insensitive fibers by default.

Fiber data, see separate fiber data sheets.

Connector types:

With all common connector types deliverable.

Connector data, see separate connector data sheets.

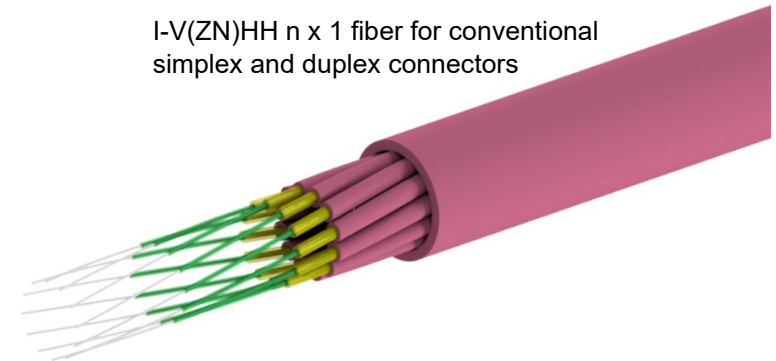

I-V(ZN)HH n x 1 fiber for conventional simplex and duplex connectors

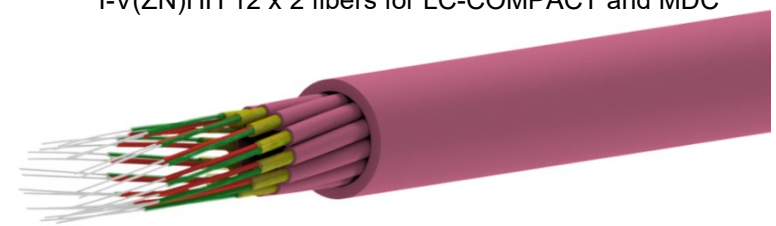

I-V(ZN)HH 12 x 2 fibers for LC-COMPACT and MDC

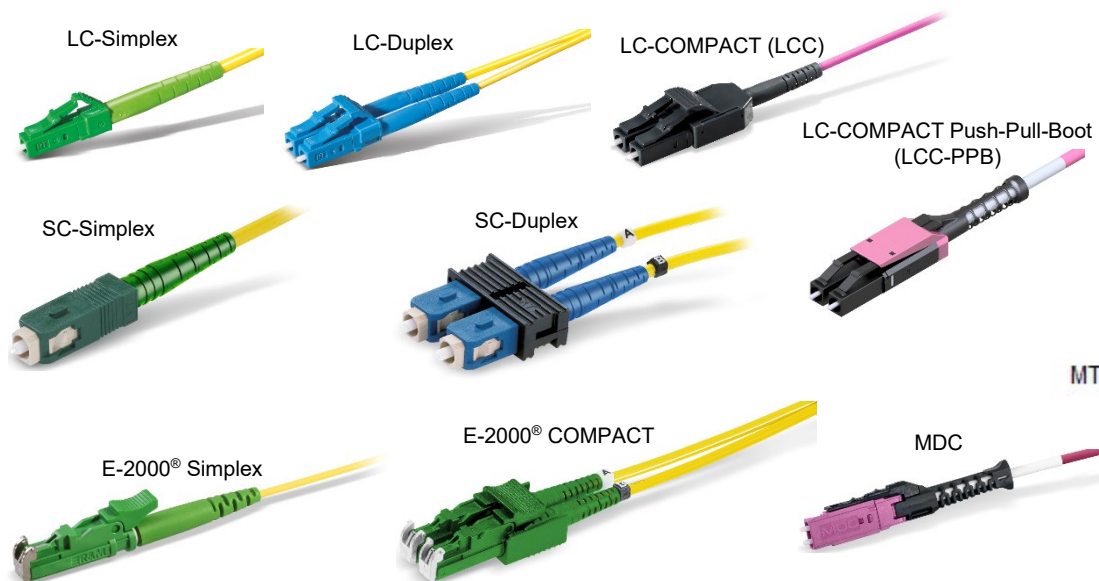

MTP® see product information
PreCONNECT® OCTO, DUODECIM und SEDECIM



MTP® Female

MTP® Male (mit Pins)

Properties:

Installation protection:

The package of application specific „variable“ legs is a not pull resistant dust-proof foil tube.

On „standard stepped“ legs you can select:

- dust-proof foil tube



- and 150 N tensile-strength, crush and kink resistant, IP50 dust-proof indoor-installation-tube

Installation Tube Indoor,
IP50 dustproof



Standard stepped “A“ leg lengths and installation tube diameters of PreCONNECT® BREAKOUT trunks, all types of connectors except SC-Duplex ²⁾					
Steps channel/fiber 1 to n: 1 = long, n = short					
Number of channels/fibers	4/8	6/12	8/16	12/24	16/32
“A” leg lengths stepped from to [cm] ¹⁾	45 to 75	45 to 75	45 to 73	45 to 89	45 to 70
Outer diameter installation tube IP50 Indoor [mm]	30	30	30	30	30

¹⁾ Production tolerance – 5 cm / ²⁾ Installation tube diameter of trunks with SC-Duplex on request

Properties:

Length definition:

- Order-length = length between the connectors of the longest legs at both sides, not between the PreCONNECT® square-interfaces.
- Possible order-lengths: From 5 to 2000 meter

Length tolerances:

Trunk length	Tolerance
<= 10m	+/- 50cm
> 10m <= 30m	+/- 100cm
> 30m <= 100m	+/- 150cm
> 100m	+/- 2%

Operating temperature range: -10°C to +60°C

Delivery form:

- Dependent on the length as cable ring or on cardboard or wooden drum
- Insertion loss and return loss measured acc. to IEC 61300-3-4, method B, MM 850/1300nm and SM 1310/1550nm, with measurement protocol
- Product label with serial number at both sides

Application of PreCONNECT® BREAKOUT Trunks and Patchcords with LC-COMPACT (LCC) and LC-COMPACT Push-Pull-Boot (LCC-PPB) in our 19" panel systems and Trunk leg lengths :

19" panel systems	LC-Duplex port density per HU	Trunks with LCC	Trunks with LCC-PPB	Patchcords with LCC	Patchcords with LCC-PPB	Trunk leg lengths
SMAP-G2 SD	48	✓	✗	✓	✗	standard stepped "A length legs"
SMAP-G2 HD	72	✓	recommended	✗	✓ required	
SMAP-G2 UHD	96	✗	✓ required	✗	✓ required	
Conventional	24	✓	✗	✓	✗	standard stepped "A length legs"
ODF LARO	144 in 5 ETSI HU	✓	recommended	✗	✓ required	extended stepped "E length legs"

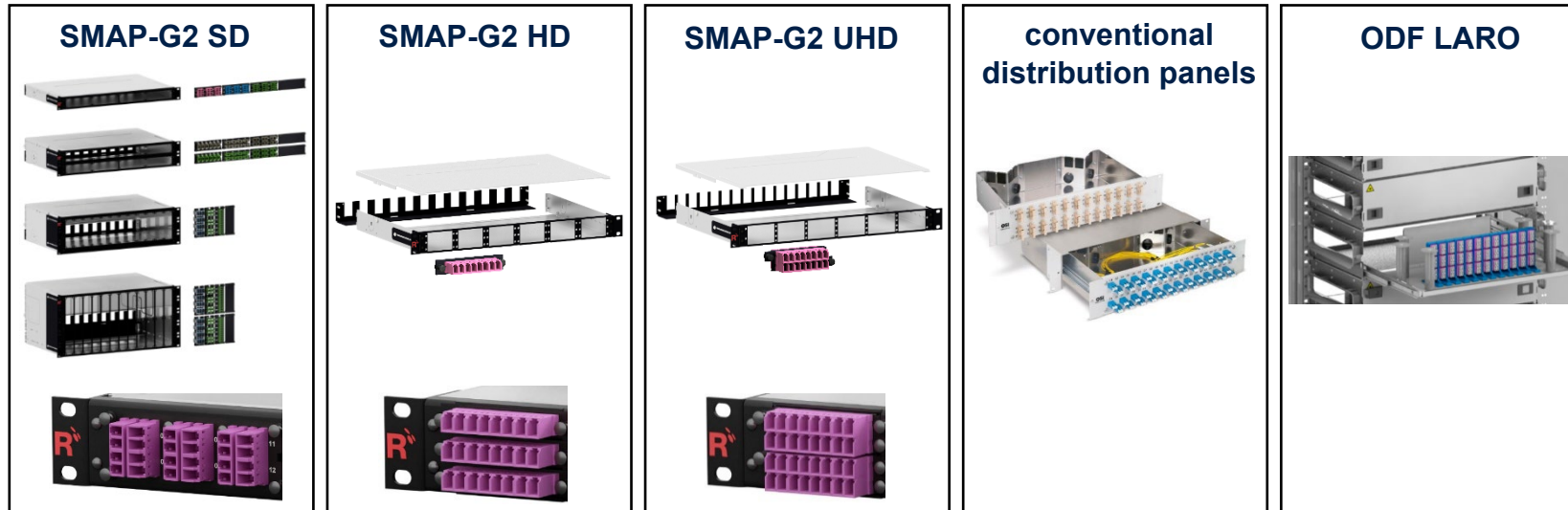

LC-COMPACT (LCC)



LC-COMPACT Push-Pull-Boot (LCC-PPB)



**PreCONNECT® BREAKOUT trunks
with indoor cables I-V(ZN)HH
CPR class Dca and Cca:**

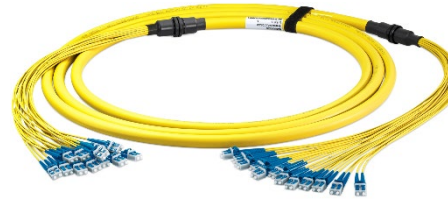

I-V(ZN)HH 12 x 1 fiber for conventional simplex and duplex connectors

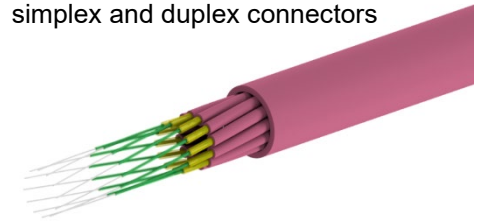

Part numbers							
Number of channels/fibers	Cable type	CPR class	Connectors on both sides	length	SM PC 0°	SM APC 8°	OM4
4	I-V(ZN)HH 4 x 1 fiber	Dca ¹⁾	LC-Simplex	variable	on request	on request	on request
			LC-Duplex	variable	036A9034G657A1	on request	036A0457OM4
			SC-Simplex	variable	036A0526G657A1	on request	on request
			SC-Duplex	variable	on request	on request	on request
			E-2000® Simplex	variable	on request	on request	on request
			E-2000® COMPACT	variable	on request	on request	on request
12	I-V(ZN)HH 12 x 1 fiber	Dca ¹⁾	LC-Simplex	variable	on request	on request	on request
			LC-Duplex	variable	036A0508G657A1	on request	on request
			SC-Simplex	variable	on request	on request	036A0527OM4
			SC-Duplex	variable	on request	on request	on request
			E-2000® Simplex	variable	on request	036A0541G657A1	on request
			E-2000® COMPACT	variable	on request	on request	on request
24	I-V(ZN)HH 24 x 1 fiber	Dca ¹⁾	LC-Simplex	variable	036A0521G657A1	on request	on request
			LC-Duplex	variable	036A0435G657A1	on request	on request
			SC-Simplex	variable	on request	on request	on request
			SC-Duplex	variable	on request	on request	on request
			E-2000® Simplex	variable	on request	036A0520G657A1	on request
			E-2000® COMPACT	variable	on request	on request	on request

¹⁾ Cca auf Anfrage
 Technical data of connectors, fibers and cables on request via the product profile of your selected trunks.

**PreCONNECT® BREAKOUT trunks
with indoor cables I-V(ZN)HH
CPR class Dca and B2ca:**



I-V(ZN)HH 12 x 2 fibers for
LC-COMPACT und MDC

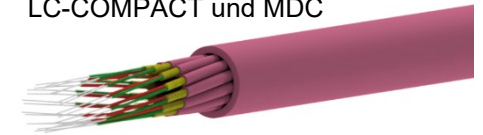

Part numbers							
Number of channels/fibers	Cable type	CPR class	Connectors on both sides	length	SM PC 0°	SM APC 8°	OM4
4/8	I-V(ZN)HH 4 x 2 fiber	Dca ²⁾	LC-COMPACT	variable	036A0532G657A1	036A0524G657A	036A0510OM4
			LC-COMPACT PPB	variable	036A0545G657A1	on request	036A0546OM4
			MDC	variable	on request	on request	on request
6/12	I-V(ZN)HH 6 x 2 fiber	Dca ²⁾	LC-COMPACT	variable	036A0503G657A	on request	036A0503OM4
			LC-COMPACT PPB	variable	on request	on request	on request
			MDC	variable	on request	on request	on request
8/16	I-V(ZN)HH 8 x 2 fiber	Dca ²⁾	LC-COMPACT	variable	036A0547G657A1	on request	036A0517OM4
			LC-COMPACT PPB	variable	036A0548G657A1	on request	036A0549OM4
			MDC	variable	on request	on request	on request
12/24	I-V(ZN)HH 12 x 2 fiber	Dca ²⁾	LC-COMPACT	variable	036A0509G657A1	036A0543G657A1	036A0504OM4
			LC-COMPACT PPB	variable	on request	on request	on request
			MDC	variable	on request	on request	036A0544OM4
16/32	I-V(ZN)HH 16 x 2 fiber	Bca	LC-COMPACT	variable	on request	on request	036A0550OM4
			LC-COMPACT PPB	variable	on request	on request	on request
			MDC	variable	on request	on request	on request

²⁾ Change to B2ca once Dca inventory is used up
 Technical data of connectors, fibers and cables on request via the product profile of your selected trunks.

About Rosenberger OSI:

Since 1991, Rosenberger Optical Solutions & Infrastructure (Rosenberger OSI) has been a recognized expert for fiber-based connectivity, cabling solutions and infrastructure services in the areas of data centers, local area networks, mobile networks and industrial applications. As an integrated solution provider, we have high expertise in the development and operational excellence in the production of system solutions for communication networks. Our comprehensive services enable the secure and efficient operation of digital infrastructures. This combination, combined with our strong customer focus, makes us unique and a strong partner in the global market.

Rosenberger OSI has been part of the globally operating Rosenberger Group since 1998. The Rosenberger Group is a leading global provider of high-frequency, high-voltage and fiber optic connectivity solutions with headquarters in Germany. For further information, please visit: www.rosenberger.com/osi

Rosenberger

Rosenberger-OSI GmbH & Co. OHG

Optical Solutions & Infrastructure | Endorferstr. 6 | 86167 Augsburg | GERMANY | Telephone: +49 821 24924-0
info-osi@rosenberger.com | www.rosenberger.com/osi

Rosenberger® is a registered trademark of Rosenberger Hochfrequenztechnik GmbH & Co. KG. All rights reserved. © Rosenberger 2022

For technical reasons, we reserve us the right to make any deviations from the illustrations in the product information.
Transfer to third party only by authority of Rosenberger-OSI GmbH & Co. OHG- All rights reserved.

Creation date: 2021-08-24
Valid since: 2022-10-06
Revision: 003