

PRODUCTPROFILE

Catalogue number: 047A0352-050

Partnumber: 777386

PreCONNECT® COPPER ToR-G2 Trunk
6 channels 10GBASE-T Class EA
Cable type: FRNC-LSZH Cat.7 S/FTP
24 PiMF AWG23/1, diameter 18.2mm
CPR Class B2ca
assembled on both sides with 6
RJ45 jacks Cat.6A shielded
Length: 50 meter

Related documents:

PRECONNECT_COPPER_TOR-G2_OE Product Information

PreCONNECT® COPPER ToR – Generation 2

PRODUCT INFORMATION



Applications:

IT room cabling within data centers and data center and EDGE computing containers

System consists of:

- Factory assembled 24-pair/6 channel Cu cables, Cat.7 S/FTP, AWG23/1 and AWG26/1, FRNC-LSZH indoor cable
- With shielded Cat. 6A RJ45 Keystone jack modules
- Suitable 19" panels
- Suitable RJ45 patchcords
- Useful accessories

Features:

- 10GBASE-T class E_A permanent link with AWG23/1 up to 90 meters
- 10GBASE-T class E_A permanent link with AWG26/1 up to 60 meters
- Diverse 19" panel selectable

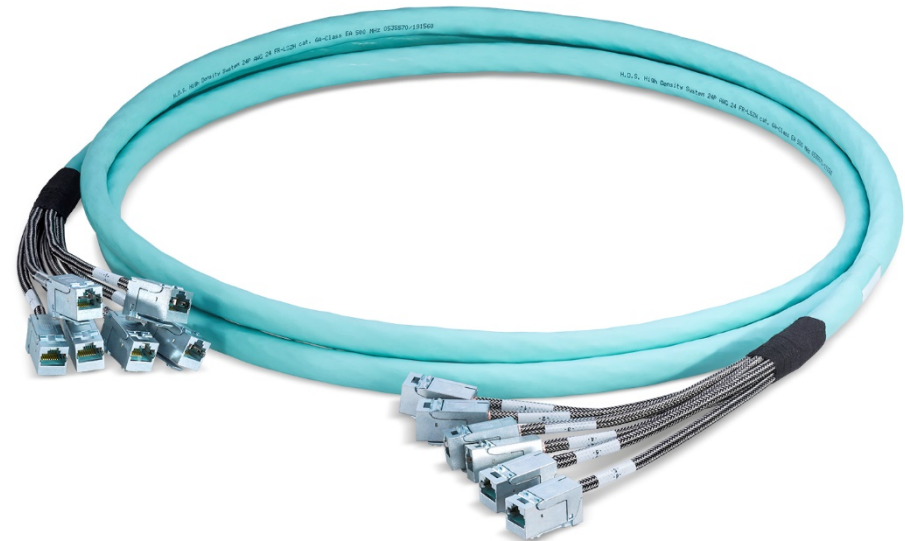
**Your benefits at a glance:**

- Cost-effective through space and weight savings by the 24-pair cable, particularly appropriate for Top-of-the-Rack (ToR) cabling
- Fast and safe installation through factory assembled Plug & Play systematic
- Highest quality and cost-efficiency through factory assembling
- PreCONNECT® cabling systems consist of perfectly harmonized modular single components

PreCONNECT® COPPER ToR-G2 trunk



PreCONNECT® COPPER 19" panels



**Mix PreCONNECT®
FIBER and COPPER ToR-G2**



**PreCONNECT® COPPER
patchcords**

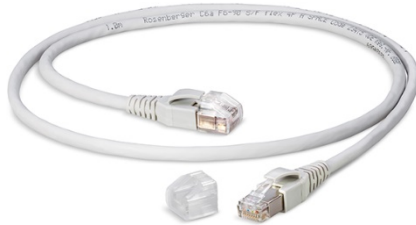

Accessories



PreCONNECT® COPPER ToR – Generation 2 is the re-design of our factory assembled copper data cable trunks optimized for „top-of-the-rack“ „plug-and-play“ installations in data centers:

PreCONNECT® COPPER ToR G2 Trunks are the consistent further development of our successful PreCONNECT® COPPER Standard Trunks, fulfilling the requirement to have thin and flexible cables for „top-of-the-rack“ cabling.

Particular suitability for „top-of-the-rack“ through the use of innovative thin, flexible Cat.7 copper data cables with 24 foil-screened solid wire pairs below an overall copper braid, with a FRNC-LSZH cable jacket. Selectively AWG23/1 or AWG26/1.

The thin and flexible cables are offering their advantages at raised-floor installations too, their much lower volume interferes the flow of the cooling-air less and they do not fill the cable-trays and the raised-floor that much.

By laying the cables within equipment racks, the cables can be routed in a manner to not interfere the flow of the cooling-air at the equipment cooling-fan's inlet and outlet sides, because of its higher flexibility and its thin diameter. So the cable itself helps your equipment cooling optimization.

Last but not least the fire load of the cable of our PreCONNECT® COPPER ToR G2 Trunks is much lower than of our PreCONNECT® COPPER Standard Trunks.

Cable types:

- 6-channel S/FTP Cat.7, solid wire foil-screened pairs, below overall copper braid, FRNC-LSZH cable jacket, color aqua
- Selectively six 4x2xAWG23/1 or six 4x2xAWG26/1
- CPR class: AWG23/1 B2ca, AWG26/1 = Cca
- Diameter: AWG23/1 = 18.2mm, AWG26/1 = 15.2mm

RJ45 jack module:

Both sides factory assembled with each six shielded Cat.6_A ISO/IEC RJ45 Keystone jack modules, fanout legs protected with overall copper braids.

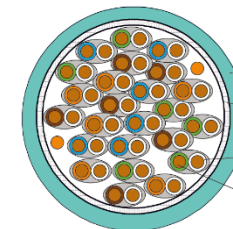

GHMT TA certificate No.: c5961X-XX

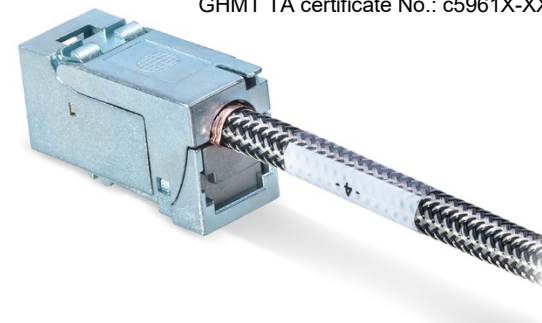

PreCONNECT® COPPER ToR – Generation 2:

The PreCONNECT® COPPER ToR G2 Trunks are fulfilling the specifications of **permanent link 10GBASE-T class E_A**:

- AWG23/1 up to 90m
- AWG26/1 up to 60m, instead of the standardized 90m

The legs of the RJ45 jacks are protected with overall copper braids, to guarantee the shielding and grounding of the entire Trunk.

The length of the legs with RJ45 jacks are matched to the corresponding 19" panels.

PreCONNECT® COPPER ToR-G2 trunks are delivered in our well known factory assembled high PreCONNECT® quality and „plug-and-play“ functionality and 100% factory measured of course. You merely must lay the cable and snap the RJ45 jacks into the 19" panels.

Polarity: 1:1 TIA 568 A

PoE: AWG23/1 and AWG26/1 applicable for PoE+

NVP for lengths measurement: AWG23/1 and AWG26/1 = 76%

Length definition:

- Order-length = length between the RJ45 jacks at both sides
- Maximum order-length, 10GBASE-T permanent link maximum length:
 - AWG23/1: From 2 to 90 meter
 - AWG26/1: From 2 to 60 meter

Delivery form: As cable ring in cardboard-box with measurement protocol

Installation protection of the factory assembled RJ45 jacks:

Within dust-proof bubble bag, as shown below.



Part numbers:

(XXX = length in meter, e.g. -035 = 35 m)

PreCONNECT® COPPER ToR G2 Trunk:

- AWG23/1 CPR class B2ca: **047A0352-XXX**
- AWG26/1 CPR class Cca: **047A0353-XXX**

Trunk length	Tolerance
<= 5m	+/- 10cm
> 5m <= 90m	+/- 2%

Leg lengths:

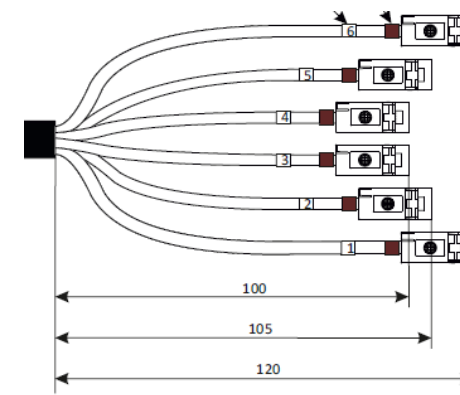

PreCONNECT® COPPER 19“ Panels:**0.5 HU fits for 24 Keystone Jacks:**

Two pcs. of this Panel above e.o. add up to 48 RJ45 Ports per HU

Material: stainless steel

Depth: 100mm

Part number: 800A0220

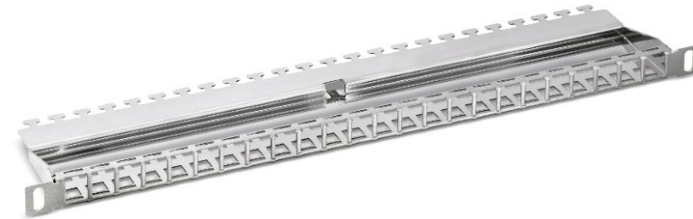
**1 HU fits for 24 Keystone Jacks:**

Material: Steel, powder-coated

Depth: 150mm

Part numbers:

RAL 7035 light gray: 800A0213

RAL 9005 black: 800A0214

**1 HU fits for 24 Keystone Jacks, 30° cable routing:**

Material: Steel, powder-coated

Depth: 120mm

Part numbers:

RAL 7035 light grey: 800A0219

RAL 9005 black: 800A0218

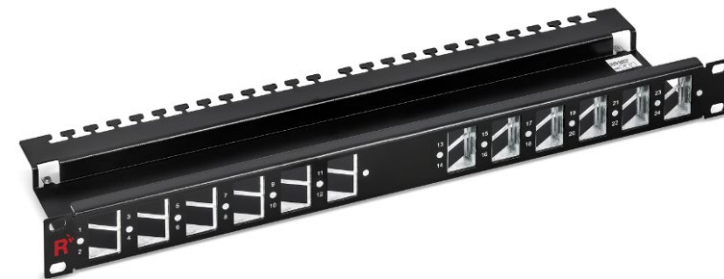

Mix PreCONNECT® FIBER and COPPER within

PreCONNECT® SMAP-G2 SD



SMAP-G2 SD 19" empty distribution panels, RAL9005 black backplane with 12 PreCONNECT® square interfaces see product information PreCONNECT® SMAP-G2 SD

Part number 1 HU, depth 300mm: **171A0001**



Fixing of PreCONNECT® COPPER ToR-G2 trunks at panel back plane using PreCONNECT® universal cable fixture. For cable diameters 6 to 18 mm.

Part number set incl. two cable ties: **111A0650**

PreCONNECT® SMAP-G2 HD



SMAP-G2 HD 19" empty distribution panels, RAL9005 black backplane with 12 PreCONNECT® square interfaces see product information PreCONNECT® SMAP-G2 HD

Part number 1 HU, 4/4 DUODECIM width partition, depth 300mm: **171H0010**

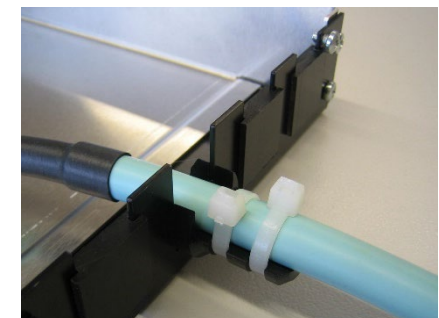

SMAP-G2 SD 6 Port RJ45 Keystone part front plate fitting for PreCONNECT® COPPER trunks with RJ45 Keystone Jacks:

Properties:

- Fitting in SMAP-G2 SD panels
- For 6 RJ45 Keystone Jacks
- Height: 1 HU
- Width: 1/4
- Toolless placement of the module cassettes into the panel from the front side, fixing with quick fasteners
- Inclusive 2m long grounding cable to connect the PFP, grounding cable is to be routed out of the panel through its back plane and attached at the grounding point of the rack
- Material and colour: steel powder coated RAL9005 black

Part numbers RAL9005 black: **170A4010**



SMAP-G2 HD 6 Port RJ45 Keystone part front plate fitting for PreCONNECT® COPPER trunks with RJ45 Keystone Jacks:

Properties:

- Fitting in SMAP-G2 HD panel with 4/4 DUODECIM width partition
- For 6 RJ45 Keystone Jacks
- Height: 1 HU
- Width: 1/4
- Toolless placement of the module cassettes into the panel from the front side, fixing with quick fasteners
- Inclusive 2m long grounding cable to connect the PFP, grounding cable is to be routed out of the panel through its back plane and attached at the grounding point of the rack
- Material and colour: steel powder coated RAL9005 black

Part numbers RAL9005 black: **170H7000**

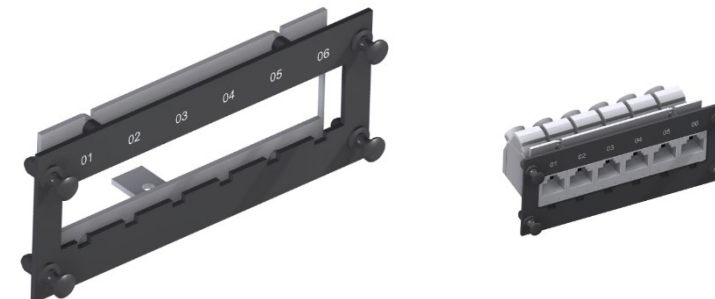

RJ45 Cat. 6A patchcords:

- Cat. 6A ISO/IEC
- Polarity 1:1 TIA 568 B
- Applicable for PoE+
- Shielded RJ45 connectors with 2 component boot with latch protection and protective cap on both sides.
- Cable type: Cat.7, S/FTP, flex, 4 foil-screened AWG27/7 pairs,
- Up to 900 MHz, FRNC-LSZH, diameter 5.7mm, color grey
- Other lengths, colors and types on request
- GHMT PVP certificate no.: c5877X-XX

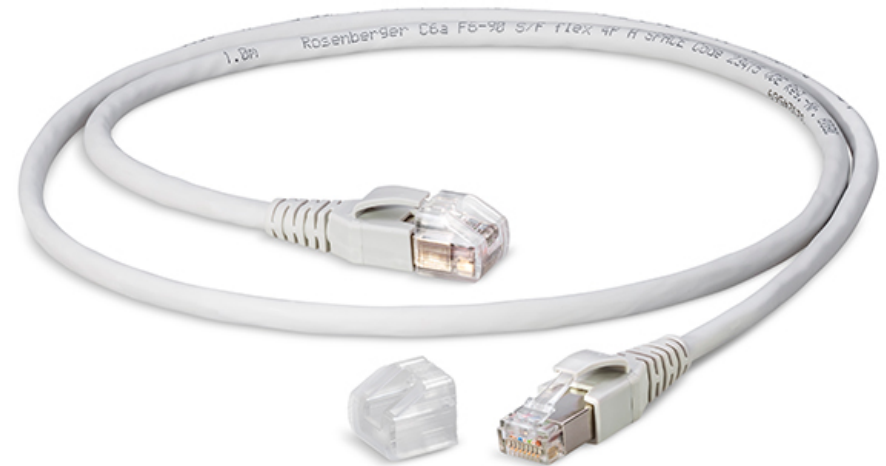

Length	Part numbers
1 meter	820A1019M-1
2 meter	820A1019M-2
3 meter	820A1019M-3
5 meter	820A1019M-5
10 meter	820A1019M-10

On request:

RJ45 Cat. 6A patchcord, AWG26/7 = 5.8mm, with RJ45 Push-Pull connector

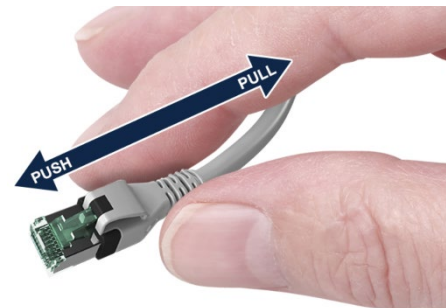

Thin RJ45 Cat. 6A patchcords:

- S/FTP AWG30 = 4.5mm
- S/FTP AWG32 = 4.0mm



For 19" panel accessories see our product information 19" panel accessories:



Labeling fields



Patchcord manager

- height units saving (0 HU) mountable in front of 19" panels
- with foldaway front cover
- with optional labelling and port address fields

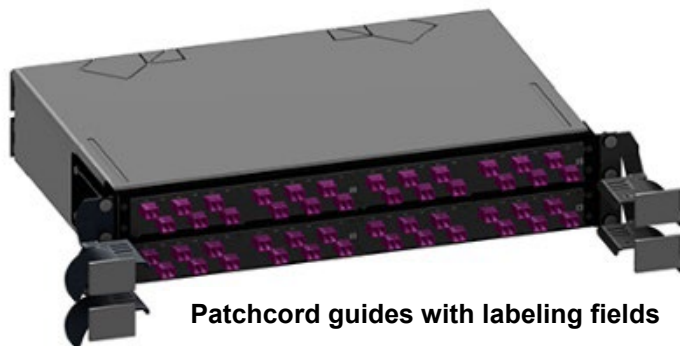

Patchcord guides with labeling fields

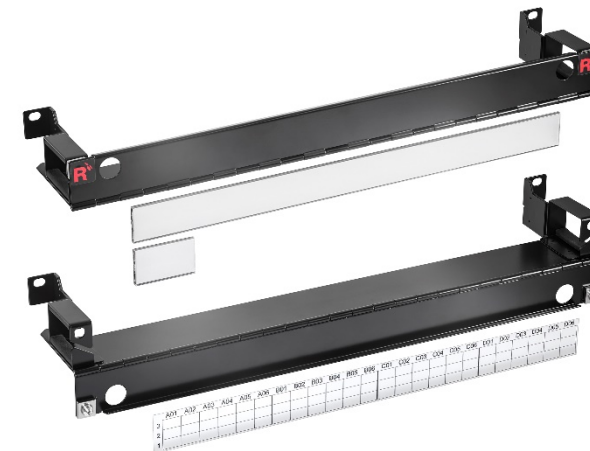

About Rosenberger OSI:

Since 1991, Rosenberger Optical Solutions & Infrastructure (Rosenberger OSI) has been a recognized expert for fiber-based connectivity, cabling solutions and infrastructure services in the areas of data centers, local area networks, mobile networks and industrial applications. As an integrated solution provider, we have high expertise in the development and operational excellence in the production of system solutions for communication networks. Our comprehensive services enable the secure and efficient operation of digital infrastructures. This combination, combined with our strong customer focus, makes us unique and a strong partner in the global market.

Rosenberger OSI has been part of the globally operating Rosenberger Group since 1998. The Rosenberger Group is a leading global provider of high-frequency, high-voltage and fiber optic connectivity solutions with headquarters in Germany. For further information, please visit:

www.rosenberger.com/osi

Rosenberger

Rosenberger-OSI GmbH & Co. OHG

Optical Solutions & Infrastructure | Endorferstr. 6 | 86167 Augsburg | GERMANY | Telefon: +49 821 24924-0
info-osi@rosenberger.com | www.rosenberger.com/osi

Rosenberger® is a registered trademark of Rosenberger Hochfrequenztechnik GmbH & Co. KG. All rights reserved. © Rosenberger 2018

For technical reasons, we reserve us the right to make any deviations from the illustrations in the product information
Transfer to third party only by authority of Rosenberger-OSI GmbH & Co. OHG- All rights reserved

Creation date: 2015-09-07

Valid since: 2021-03-18

Revision 008